



**AGAPITO**   
INDUSTRIAS

**CATÁLOGO GENERAL**  
GENERAL CATALOG  
CATALOGUE GÉNÉRAL



I N D U S T R I A S  
AGAPITO 

## Parques infantiles | 6

Playground equipment / Jeux d'extérieur

<b>Serie Spooky</b> Spooky Series / Série Spooky	8
<b>Serie Tribox</b> Tribox Series / Série Tribox	22
<b>Serie Juga</b> Juga Series / Série Juga	42
<b>Serie Veleta</b> Veleta Series / Série Veleta	54
<b>Serie Playkit</b> Playkit Series / Série Playkit	74
<b>Circuito estimulación temprana</b> Early stimulation circuit / Circuit de stimulation précoce	82
<b>Serie integración</b> Inclusive playgrounds / Série d'intégration	96
<b>Juegos Temáticos</b> Themed Playgrounds / Jeux À Thèmes	112
<b>Complementos</b> Accessories / Compléments	122

## Mobiliario urbano | 128

Street furniture / Mobilier urbain

<b>Serie reciclado</b> Recycled series / Plastique recyclé	132
<b>Bancos</b> Benches / Bancs	135
<b>Bancos y Mesas</b> Benches and Tables / Bancs et Tables	136
<b>Papeleras y Jardineras</b> Litter Bins and Planters / Corbeilles et Jardinières	137
<b>Aparcabicis y carteles</b> Bike Racks and Signs / Parkings-Vélos Panneau d'information	138
<b>SERIE DOMO</b> DOMO SERIES / SÉRIE DOMO	140

## Circuitos deportivos | 150

Outdoor sport circuits / Circuits sportifs

<b>Parques de Calistenia</b> Street-Workout Equipment / Parcs Street Workout	152
<b>Parque de Mayores</b> Senior playground / Parc pour seniors	172
<b>Gimnasio en la calle</b> Outdoor gym / Gym en plein air	188
<b>Circuito Nforma</b> Nforma Circuit / Circuit Nforme	198
<b>Pista Multideporte</b> Multisport Courses / Terrain Multisports	202
<b>Circuito Vita</b> Vita Circuit / Circuit Vita	206
<b>Circuito Agility</b> Agility Circuit / Circuit Agility	214

## Sombras Textiles | 222

Textile Shades / Nuances Textiles



## ENG

---

**Industrias Agapito** is a fifth generation family business, dedicated to the design, manufacturing, installation and maintenance of Urban Equipments. The factory is over 20.000 sqm. nowadays and is located in Zaragoza (Spain). The company has implemented ISO9001 Quality Management System and ISO14001 Enviromental System.

Since 40 years ago, the main activity of the company is designing and manufacturing Children Playgrounds, Site Furnishing and Outdoor Sport Circuits. Our products are certified under its respective European Standards and are exported to more than 25 countries.

We design and manufacture our own products. Complete manufacturing of our products, the use of lastgeneration raw materials, and our extensive manufacturing experience let us offer maximum quality products with excelent value for money.

Over 100 years of history, more than 40 of them designing and manufacturing site furnishings, Industrias Agapito participates in the progress and new trends of this sector to develop its high quality and security products.

## ESP

---

**Industrias Agapito** es una empresa familiar de quinta generación, dedicada al diseño, fabricación, instalación y mantenimiento de Equipamientos Urbanos. Cuenta en la actualidad con unas instalaciones de 20.000 m2 en Zaragoza (España) y tiene implantados Sistemas de Gestión de la Calidad ISO9001 y Medioambiental ISO14001.

La actividad principal de la empresa desde hace más de 40 años es el diseño y fabricación de Juegos Infantiles, Mobiliario Urbano y Equipamiento Deportivo. Nuestros productos están certificados bajo sus correspondientes normativas europeas de producto y se exportan fuera de nuestras fronteras a más de 25 países.

Diseñamos y fabricamos nuestros propios productos. La fabricación integral propia de nuestros productos, la utilización de materias primas de última generación, y nuestra dilatada experiencia fabril nos permite ofrecer equipamientos de máxima calidad y una excelente relación calidad-precio.

Con más de 100 años de existencia y más de 40 diseñando y fabricando equipamientos urbanos, Industrias Agapito participa en la evolución y nuevas tendencias de este sector para desarrollar sus productos de alta calidad y máxima seguridad que, junto con el diseño, son los pilares en los que se basa nuestra filosofía de fabricación.

## POR

---

**Indústrias Agapito** é uma empresa familiar que está na quinta geração, com ampla experiência na concepção e fabricação de equipamento urbano. A Agapito dispõe de uma fábrica em Zaragoza (Espanha) de mais de 20.000 m2 e possui sistema de gestão de qualidade ISO9001 e ambiental ISO14001.

Há mais de 40 anos trabalha na concepção e fabricação de equipamento para playgrounds, mobiliário urbano e equipamento desportivo para jovens e adultos. Nossos produtos são certificados sob suas respectivas normas de segurança europeia, e são exportados para mais de 25 países fora das nossas fronteiras incluindo o Brasil que acaba de ganhar uma nova norma de segurança para playgrounds bem parecida com as normas europeias, a ABNT NBR 16071:2012 - Playgrounds.

Desenhamos e fabricamos nossos próprios produtos. A fabricação integral própria de nossos produtos, a utilização de matérias-primas de última geração e nossa larga experiência fabril nos permitem oferecer equipamentos de máxima qualidade e uma excelente relação qualidade/preço.

Com mais de 100 anos de existência e mais de 40 desenhando e fabricando equipamentos urbanos, Indústrias Agapito participa na evolução e novas tendências deste setor para desenvolver seus produtos de alta qualidade e máxima segurança que, junto com o desenho, são pilares nos que se baseam nossa filosofia de fabricação.

## FR

**Industrias Agapito** est une entreprise familiale de cinquième génération spécialisée dans la conception, la fabrication, la pose et l'entretien d'Equipements Urbains. Notre entreprise, située à Saragosse, en Espagne, occupe actuellement une surface de 20.000 m<sup>2</sup> et dispose d'un Système de Gestion de la Qualité ISO9001 et de l'Environnement ISO14001.

L'activité principale de l'entreprise depuis plus de 40 ans est la conception et la fabrication de jeux de plein air, de mobilier urbain et d'équipement sportif. Nos produits, certifiés conforme à la norme européenne correspondant à chaque produit, sont exportés hors de nos frontières, à plus de 25 pays.

Nous concevons et fabriquons nos produits. La fabrication intégrale de nos produits, l'utilisation de matières premières de dernière génération et notre expertise étendue de fabrication nous permettent d'offrir des équipements de qualité supérieure et un excellent rapport qualité prix.

Avec plus de 100 ans d'existence et plus de 40 ans consacrés à la conception et à la fabrication d'équipement urbain, Industrias Agapito participe à l'évolution du secteur et à l'émergence de nouvelles tendances pour développer des produits de haute qualité et sécurité maximale qui, conjointement avec la conception, constituent les piliers de notre philosophie de fabrication.

## DE

**Industrias Agapito** ist ein Familienunternehmen in fünfter Generation, das sich dem Design, der Herstellung, Installation und Wartung städtischer Ausstattungen widmet. Zurzeit verfügt es über 20.000m<sup>2</sup> Betriebsfläche in Saragossa (Spanien) und hat das Qualitätskontrollsystem ISO9001, die Umweltmanagementnorm ISO14001 und das System für Forschung eingeführt.

Seit über 40 Jahren besteht die Haupttätigkeit des Unternehmens darin, Spielplatzeinrichtungen, urbanes Mobiliar und Sporteinrichtungen zu entwerfen und herzustellen. Unsere Produkte sind nach den entsprechenden europäischen Produktnormen zertifiziert und werden in mehr als 25 Länder exportiert.

Wir entwerfen und stellen unsere eigenen Produkte her. Dadurch dass wir den kompletten Herstellungsprozess selbst durchführen, qualitativ hochwertige Rohstoffe, die auf dem höchsten technischen Stand sind, verwenden und über langjährige Produktionserfahrung verfügen, können wir qualitativ hochwertige Produkte mit einem hervorragenden Preis-Leistungsverhältnis anbieten.

Als Unternehmen, das seit über 100 Jahren besteht und seit über 40 Jahren städtische Ausstattungen entwirft und herstellt, verfolgt Industrias Agapito die Entwicklung und neuen Tendenzen dieses Sektors, um seine qualitativ hochwertigen und hochsicheren Produkte zu entwickeln, die zusammen mit dem Design die Pfeiler darstellen, auf die sich unsere Produktionsphilosophie gründet.

## AR

أغيبيتو للصناعة، هي شركة عائلية يعود تأسيسها إلى خمسة أجيال، يشمل نشاطها تصميم وتصنيع وتركيب وصيانة تجهيزات المرافق العامة. تبلغ مساحتها 20.000 متراً مربعاً ومقرها في مدينة سرقسطة في إسبانيا. لقد أدخل إليها برامج إدارة نظم الجودة ISO9001 ونظم البيئة ISO14001.

يعتمد نشاط الشركة الرئيسي منذ أكثر من 40 عاماً على تصميم وتصنيع ألعاب للحدائق والمنتزهات، أثاث الشوارع والتجهيزات الرياضية. منتجاتنا معتمدة من قبل TÜV SUD وفقاً لمعاييرها الأوروبية ويتم تصديرها إلى أكثر من 25 بلداً.

نحن نصمم ونصنع منتجاتنا الخاصة بنا. إن تصنيعنا الكامل لمنتجاتنا واستعمالنا مواد خام عالية الجودة إضافة إلى خبرتنا الواسعة في التصنيع، يتيح لنا تقديم تجهيزات عالية الجودة بأسعار مميزة.

أكثر من 100 عام على تواجدها و40 عام في تصميم وتصنيع تجهيزات المرافق العامة، تضمن لصناعات أغابيتو المساهمة في تنمية هذا القطاع باتجاهات جديدة لتطوير منتجاتها بأحسن التصاميم والجودة وبأقصى درجات الأمان التي تعتبرها من الركائز التي تبني عليها فلسفتها في التصنيع.



PORTUGAL



HOLANDA



FRANCE



U.K.



ISRAEL



CABO VERDE

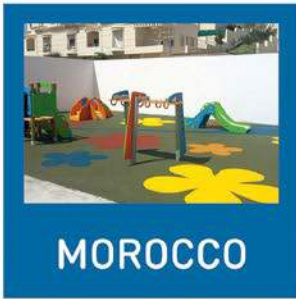

MOROCCO

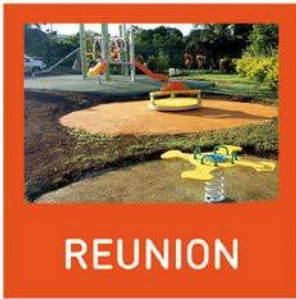

REUNION

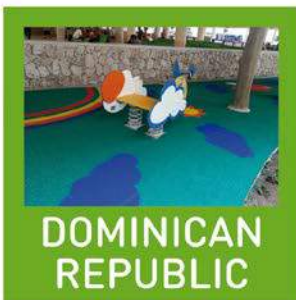

DOMINICAN REPUBLIC

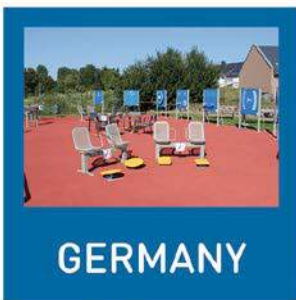

GERMANY



BRAZIL



OMAN

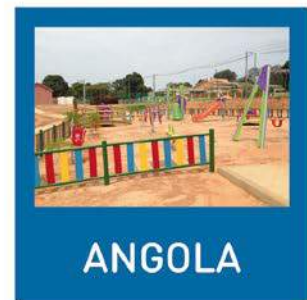

ANGOLA



EMIRATS



**AGAPITO URBANA**



ISRAEL



SWITZERLAND

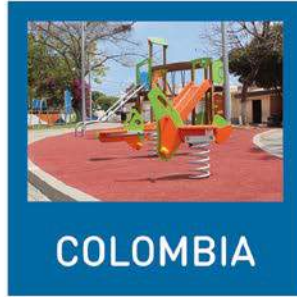

COLOMBIA



HONG KONG



QATAR

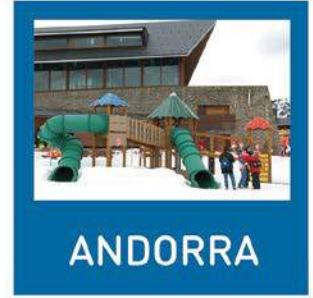

ANDORRA

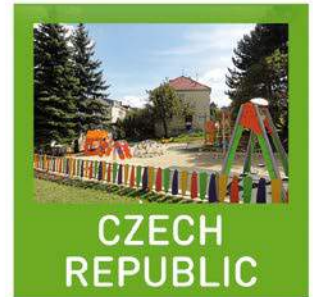

CZECH REPUBLIC

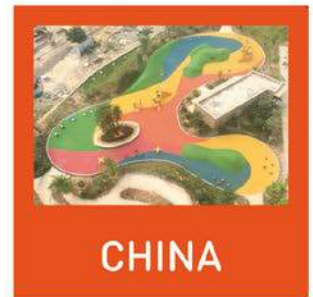

CHINA

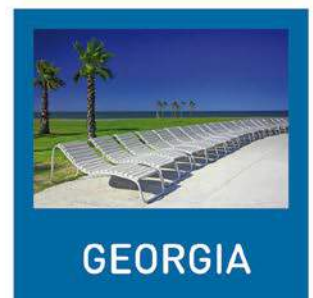

GEORGIA

## INDUSTRIES



UNITED STATES



SINGAPORE

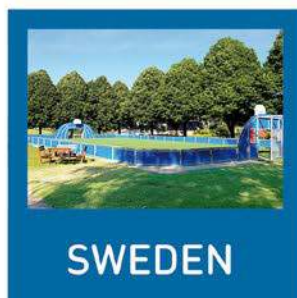

SWEDEN



BELGIUM

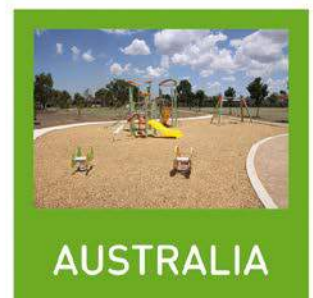

AUSTRALIA



Producto certificado bajo la Norma EN-1176  
EN-1176 Certified product  
Produit certifié conforme à la norme EN-1176



Apto para niños con discapacidad  
Handicapped-ready playground  
Jeu accessible aux enfants handicapés



Opción tobogán: P- Poliéster/Polietileno; X- Acero inoxidable con laterales de polietileno; U: gruta  
Slide choice: P: Polyester/HDPE ;X: Stainless Steel ramp and HDPE sides; U: Tube Slide  
Toboggan en option: P: Poliester/PEHD; X: Acier inoxydable avec panneaux en PEHD ; U: toboggan fermé en PEHD



### PARQUES INFANTILES

En estas páginas encontrará una gran variedad de juegos infantiles para satisfacer todos gustos y presupuestos. Todos están fabricados exclusivamente con paneles de polietileno de alta densidad multicolor, sin mantenimiento, anti-grafiti, con acabado rugoso anti-rayas, de 2 cm de espesor. Los grabados son indelebles, realizados en polietileno tipo sándwich. Las zonas de pisada están realizadas con polietileno con revestimiento antideslizante de caucho.

La estructura de los juegos, según la serie, es de acero galvanizado con pintura de poliéster termoendurecida. o de madera Pino Sylvestris, calidad V, de procedencia PEFC certificada, laminado y encolado, con tratamiento en autoclave certificado a nivel P4 según Normativa Europea EN351.2. La madera se acaba con un protector a poro abierto lasur.

Las partes metálicas, fabricadas en acero de alta calidad, son galvanizadas o con plastificado de alta resistencia.

Giros y piezas sometidas a desgaste son cuidadosamente diseñados para tener una larga vida.

### PLAYGROUND EQUIPMENT

On these pages you will find a variety of children playgrounds for all requirements and budgets. The panels of all playgrounds are manufactured with maintenance-free, antigraffiti, with scratch-resistant, rugose texture, 2 cm thick HDPE. Engravings are indelible, made on sandwich HDPE. Stepping areas are made with anti-slippery rubber-covered HDPE.

Playground structure, according to the Series, is made with galvanized steel with thermo-hardened painting or vacuum pressure treated wood in compliance with class P4 according to EN351.2 Standard, finished with open pore lasur paint finish. Galvanized metal elements, with a thermohardened polyester paint finish.

Drafts and other parts likely to be worn out are carefully designed to be long-lasting.



# Parques infantiles

## Playground equipment

### Jeux d'extérieur



#### JEUX D'EXTÉRIEUR

Vous trouverez dans ces pages une grande variété de jeux d'extérieur, pour satisfaire tous les goûts et tous les budgets.

Pour la fabrication de nos jeux nous utilisons exclusivement des panneaux de polyéthylène de haute densité, sans entretien, antigraffiti, finition rugueuse anti-rayures, de 2 cm d'épaisseur. Les décorations sont indélébiles, gravées dans le polyéthylène type sandwich. Les zones de toucher sont réalisées en polyéthylène revêtu de caoutchouc anti-dérapant.

Suivant la série, la structure des jeux est en acier galvanisé avec une peinture de polyester thermo endurcie ou en bois de pin Sylvestre de qualité V, origine certifiée PEFC, lamellé collé, traité en autoclave classe IV selon la norme Européenne EN351.2. Finition du bois par application de lasure à pores ouverts.

Les parties métalliques, fabriquées en acier de haute qualité, sont galvanisées ou recouvertes d'un revêtement plastifié de haute résistance.

Les pièces de tournage et, en général, toutes les pièces soumises à l'usure, sont soigneusement conçues pour avoir une longue durée de vie.



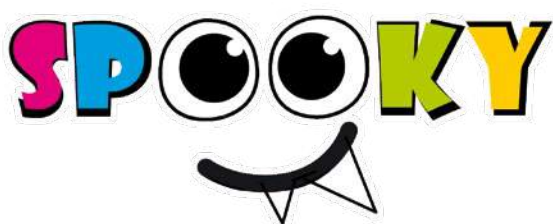

# Serie SPOOKY

## SPOOKY Series

## Série SPOOKY

La serie Spooky de juegos infantiles para parques públicos está compuesta por un atractivo y funcional conjunto de multijuegos, juegos de muelle, toboganes, columpios y casitas.

Destaca su atrevido y colorido diseño, inspirado en una divertida familia de Monsters fruto de un singular proyecto de innovación y creatividad. Su misión es promover la imaginación de los más pequeños y facilitar que vivan las más divertidas fantasías en un entorno controlado y seguro fabricado y certificado conforme a la normativa europea UNE EN 1176:2018.

Los multijuegos con aspecto de Monsters están formados por estructuras de torres unidas entre sí por diferentes sistemas de puentes de cuerdas, puentes móviles, barras o túneles de gateo. A través de rampas, paredes de trepa, rocódromos, escaleras de cuerdas y redes los niños podrán acceder al interior de los Monster y salir de ellos deslizándose por toboganes de polietileno, toboganes de acero inoxidable, toboganes de barras o divertidas barras de bomberos.

En la fabricación de esta gama infantil se utiliza polietileno de alta densidad con un alto porcentaje de plástico reciclado, el cual está protegido con recubrimiento de goma antideslizante en las zonas requeridas. Las estructuras se fabrican con acero galvanizado pintado con pintura de poliéster termoendurecida que le confiere una gran resistencia a la intemperie y se ensamblan con tornillería inoxidable protegida con tapones de poliamida.

The Spooky Series for children Playsets in public spaces is composed by an attractive and functional set of Playsets, Springs, Slides, Swings and Little houses.

Its bold and colorful design stands out, inspired in a funny Monsters family as a result of a singular innovation and creative project. Its mission is to promote the youngest children imagination and facilitate them to experience their most enjoyable fantasies in a controlled and safe environment produced and certified in compliance with the European Standards UNE EN 1176:2018.

The Monsters appearance Playsets are made of structural towers united amongst them by different systems such as rope bridges, movable bridges, bars or crawling tunnels. Through ramps, climbing walls, rope ladders and nets, the children will be able to access into the interior of the Monsters and exit by sliding through HDPE slides, stainless steel slides, bars-slides or funny fire poles.

In the manufacturing of this children high density polyethylene with a high composition of recycled plastic, which is covered by anti-slippery rubber in the required zones. The structures are made of galvanized Steel using a thermo-hardened polyester paint, offering a great resistance towards the outdoors and it is ensemble with stainless steel screws protected with polyamide caps.

La série Spooky est une gamme de jeux pour enfants destinés aux parcs publics, composée par un ensemble amusant et fonctionnel de multi jeux, jeux sur ressort, tobogans, balançoires et maisonnette.

Est mis en évidence son design audacieux et coloré, inspiré par une famille amusante de Monstres, résultat d'un projet unique d'innovation et de créativité. Sa mission est de promouvoir l'imagination des plus petits et de leur permettre de vivre les plus amusantes aventures dans un environnement contrôlé et sûr, fabriqué et certifié conformément à la réglementation européenne UNE EN 1176:2018.

Les multi jeux qui ressemblent à des monstres sont composés de modules hexagonaux empilés formant des tours reliées entre elles par différents systèmes; ponts de corde, ponts mobiles, des barres ou des tunnels à ramper. Les enfants peuvent accéder à l'intérieur des Monstres par des rampes, des barres, des murs d'escalade, des échelles de corde et des filets et s'échapper par des glissières en polyéthylène ou acier inoxydable, des barres de glisse ou des barres de pompiers amusantes.

Pour la fabrication de cette gamme pour enfants, on utilise du polyéthylène de haute densité avec un pourcentage élevé de plastique recyclé, et pour les zones requises un revêtement en caoutchouc antidérapant. Les structures sont fabriquées en acier galvanisé peint avec une peinture en polyester thermodurcissable pour une grande résistance aux intempéries. L'assemblage se fait avec des vis en acier inoxydable protégées par des bouchons en polyamide.



Galería de fotos  
Photo gallery  
Galerie de photos



PARQUES INFANTILES / PLAYGROUND EQUIPMENT / JEUX D'EXTÉRIEUR  
 SERIE **SPOOKY** / **SPOOKY** SERIES / SÉRIE **SPOOKY**



R3618



R4651



R4654



R4655



R5220



R5221



R5222



R4150



R4150C



R4150M



R4150CD



R4150MD



R4152



R4850



R5055



R5056

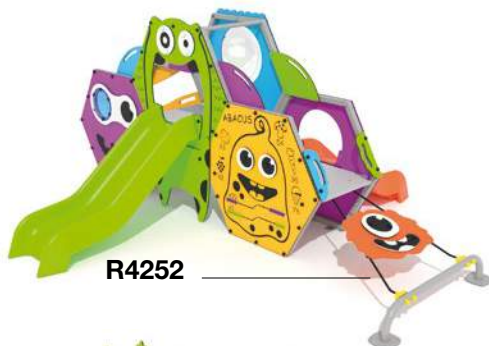

R4252



R4253



R4254



R4255



R4256

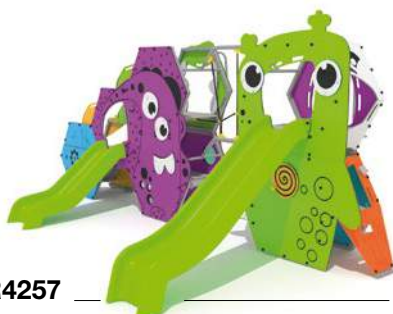

R4257



R4258



R4259

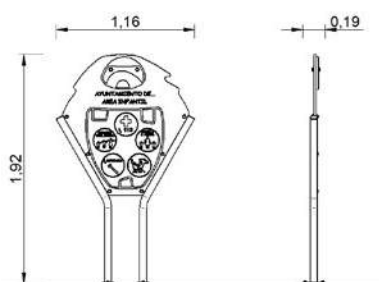

**Cartel Área Infantil SPOOKY**  
 SPOOKY Playground Area Sign  
 Panneau d'Information SPOOKY

**R3618**

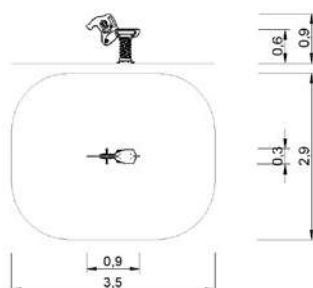

**Muelle SPOOKY Chismoso**  
 SPOOKY Nosey Spring Rider  
 Jeu à Ressort SPOOKY Pipelette

**R4651**

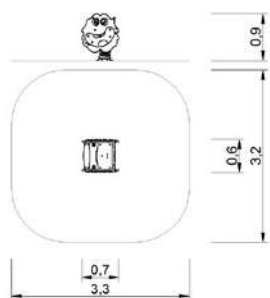

**Muelle Integracion SPOOKY Pelusa**  
 Handicapped-Ready SPOOKY Fluffy Spring Rider  
 Jeu à Ressort d'Integracion SPOOKY Douillet

**R4654**

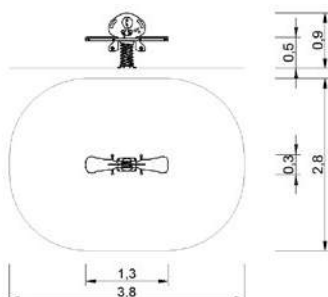

**Muelle Doble SPOOKY Cíclope**  
 SPOOKY Cyclops Double Spring Rider  
 Jeu à Ressort Double SPOOKY Cyclope

**R4655**





**Túnel SPOOKY Pelusa**  
 SPOOKY Fluffy Tunnel  
 Tunnel SPOOKY Douillet

R5220

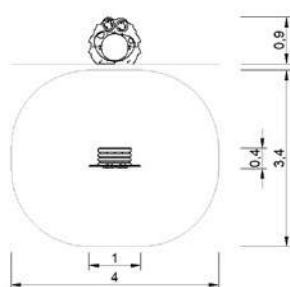

**Túnel SPOOKY Ojitos**  
 SPOOKY Little Eyes Tunnel  
 Tunnel SPOOKY Petits Yeux

R5221

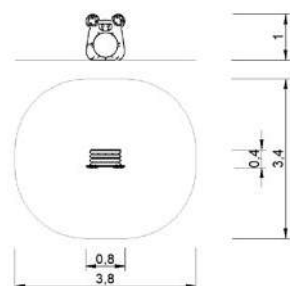

**Túnel SPOOKY Bigotes**  
 SPOOKY Moustache Tunnel  
 Tunnel SPOOKY Moustaches

R5222

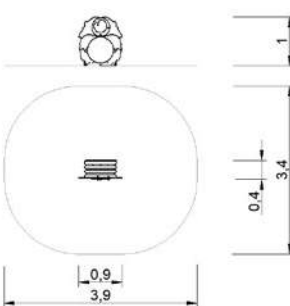

**Tobogan SPOOKY Viscoso**  
 SPOOKY Sticky Slide  
 Toboggan SPOOKY Visqueux

R4850

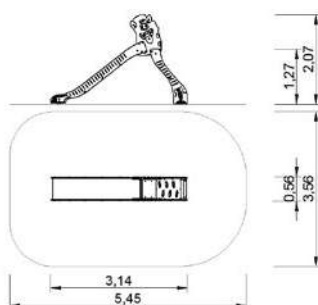



**Columpio SPOOKY Pato**  
 SPOOKY Clumsy Swing  
 Portique SPOOKY Maladroit

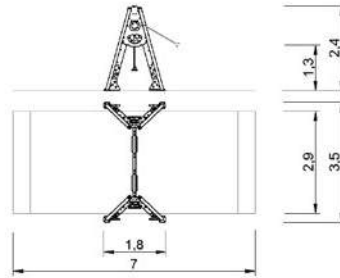

**R4150**



**Columpio SPOOKY Pato**  
 SPOOKY Clumsy Swing  
 Portique SPOOKY Maladroit

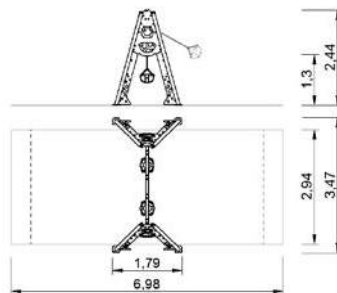

**R4150C**



**Columpio SPOOKY Pato**  
 SPOOKY Clumsy Swing  
 Portique SPOOKY Maladroit

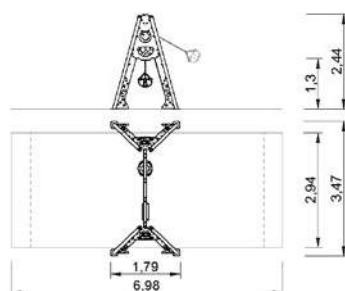

**R4150M**





**Columpio SPOOKY Patozo de Integración**  
 Inclusive SPOOKY Clumsy Swing  
 Portique SPOOKY Maladroit d'Intégration

R4150MCD

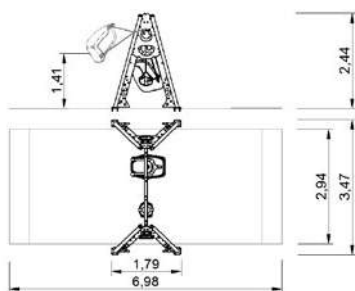

**Columpio SPOOKY Patozo de Integración**  
 Inclusive SPOOKY Clumsy Swing  
 Portique SPOOKY Maladroit d'Intégration

R4150MD

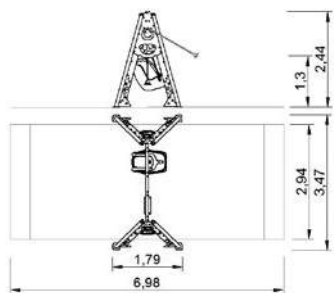

**Columpio Nido SPOOKY Patozo**  
 Nest SPOOKY Clumsy Swing  
 Portique Nid SPOOKY Maladroit

R4152

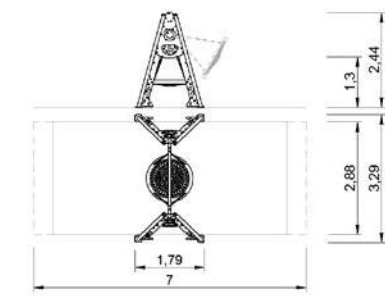





**Casita Integracion SPOOKY Pasadizo**  
 Alley SPOOKY House  
 Maisonnette SPOOKY Cachete

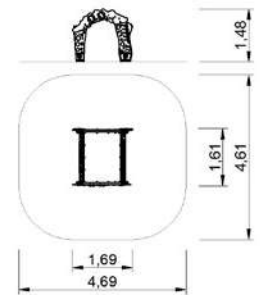

**R5055**



**Casita SPOOKY Tragona**  
 SPOOKY Big Eater Little House  
 Petite Maison SPOOKY Gloutonne

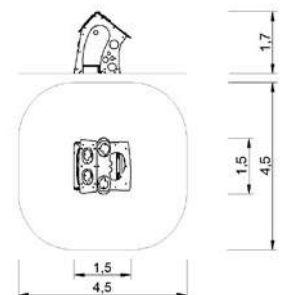

**R5056**





### SPOOKY HILL

R4252P / R4252X

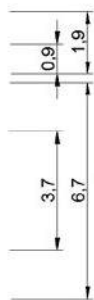
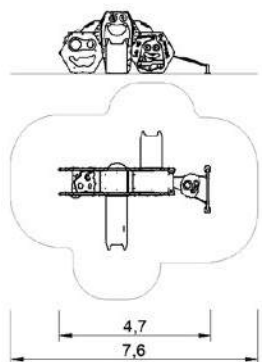

### SPOOKY FOOTBRIDGE

R4253P / R4253X

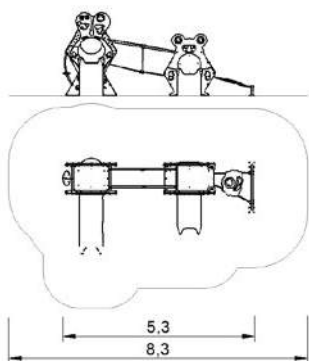

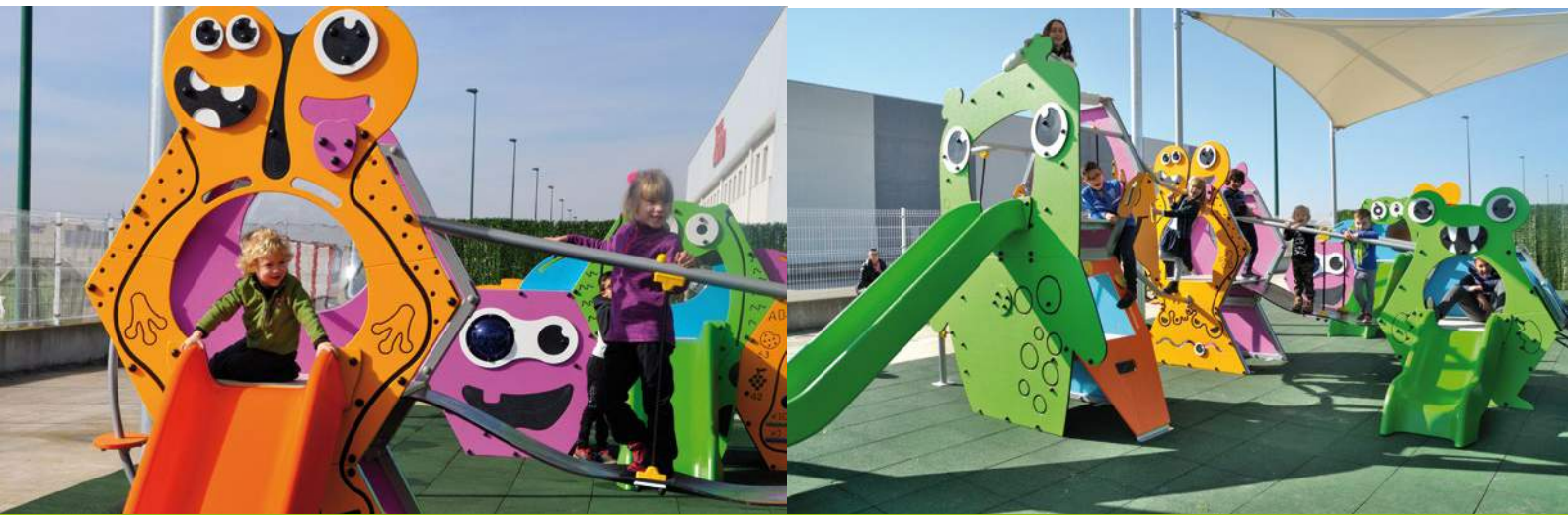

**SPOOKY TUNNEL**  
**R4254P / R4254X**





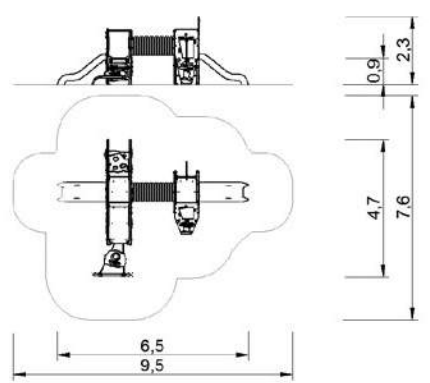

**SPOOKY CLIFF**  
**R4255P / R4255X**





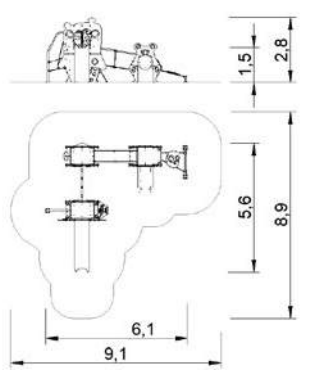



**SECRET PASSAGE SPOOKY**

**R4256P / R4256X**

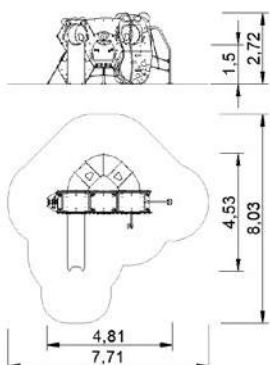

**SPOOKY ILLUSIONS**

**R4257P / R4257X**

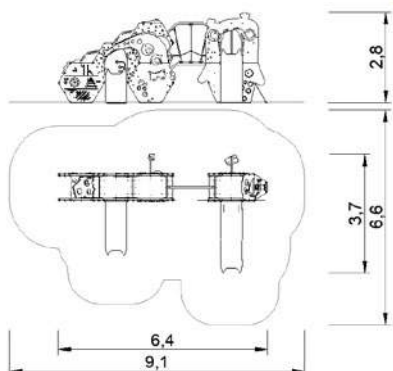



**SPOOKY DOUBLE TUNNEL**

**R4258P / R4258X**

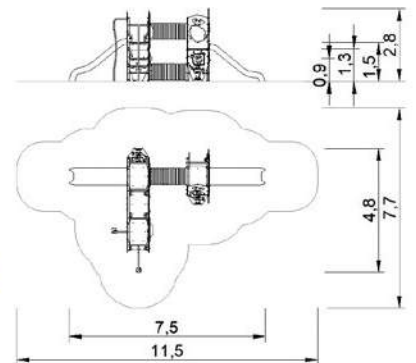

**SPOOKY JELLY**

**R4259P / R4259X**

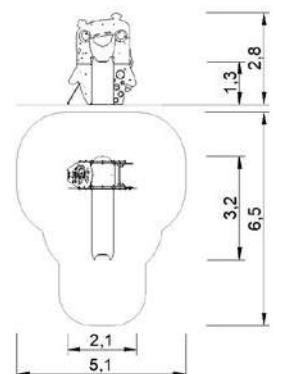





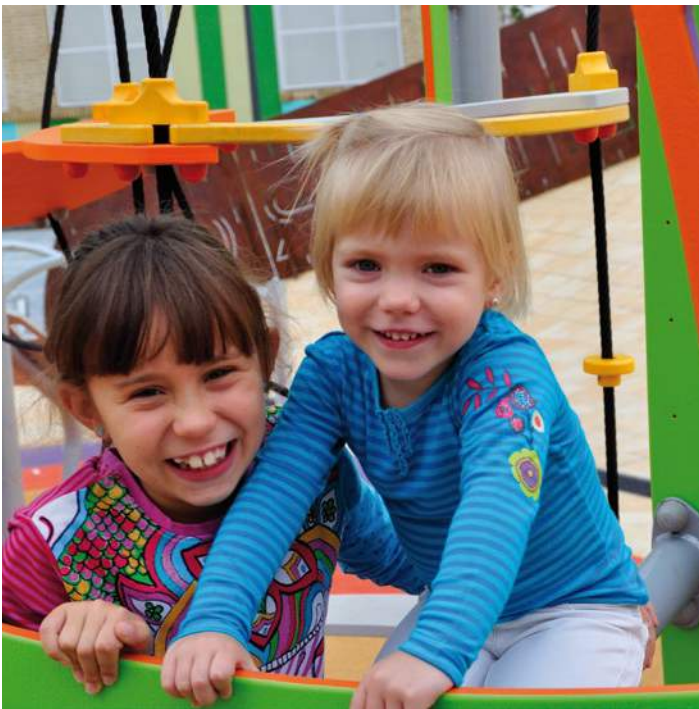





# Serie Tribox

## Tribox Series

## Série Tribox



### SERIE TRIBOX

La Serie TRIBOX es una gama de elementos que integra el juego, la destreza, el equilibrio, ejercicio físico y sociabilidad, todo ello bajo una estética impactante y muy actual que se adapta a cualquier proyecto urbanístico actual. Su diseño modular permite ofrecer acertadas soluciones de juego para cualquier área infantil y edad de uso.

Fabricada con materiales de máxima calidad, estructuras de acero galvanizado con pintura termoendurecida, paneles de polietileno de alta densidad, redes de trepa de polipropileno con alma de acero y zonas de pisada con polietileno recubierto de caucho antideslizante.

### TRIBOX SERIES

The TRIBOX series is a range that integrates play, dexterity, balance, exercise and sociability, combined in a striking and very modern style that adapts perfectly to any current development project. Its modular design allows it to offer successful play solutions for any playground and age group.

Made with the highest quality materials: galvanised steel structures with thermo-hardened paint, high-density polyethylene, polypropylene climbing nets with steel cores, tread areas with non-slip rubber-coated polyethylene.

### SÉRIE TRIBOX

La Série de jeux TRIBOX est une gamme qui intègre jeu, habileté, équilibre, exercice physique et sociabilité ; ceci accompagné d'une esthétique impressionnante et très actuelle, qui s'adapte à tout projet urbanistique actuel. Son design modulaire permet d'offrir des solutions judicieuses de jeu pour tout aire enfantine et tout âge d'utilisation.

Fabriquée en matériaux de la plus haute qualité, structures en acier galvanisé avec peinture polyester thermodurcie, panneaux en polyéthylène de haute densité, filets en polypropylène avec âme en acier et sols revêtus de caoutchouc antidérapant.



Galería de fotos  
Photo gallery  
Galerie de photos



PARQUES INFANTILES / PLAYGROUND EQUIPMENT / JEUX D'EXTÉRIEUR  
**SERIE TRIBOX / TRIBOX SERIES / SÉRIE TRIBOX**



R4110



R4110C



R4110M



R4110MCD



R4110MD



R4112



R44010



R4613



R4616



R4617



R4650



R4665



R4672



R4620

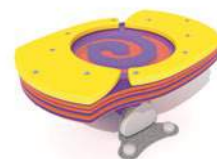

R4700

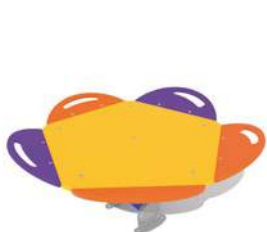

R4705



R4710



R4715



R4725



R4501



R4504



R4505



R4507



R4808



R4824



R4826



R5015



R4960



R4962



R4963



R3538



R3614



R4268



R4275



R4285



R4286



R4287



R4288



R4289



R4291



R4292



R4293



R4294



R4295



R4296



R4297



R4298



R4299



**Columpio Tribox**  
 Tribox swing  
 Portique Tribox

**R4110**

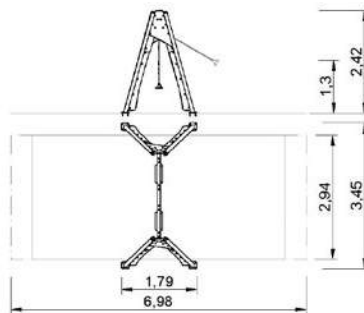

**Columpio Tribox cuna**  
 Tribox cradle swing  
 Portique Tribox sièges bébé

**R4110C**

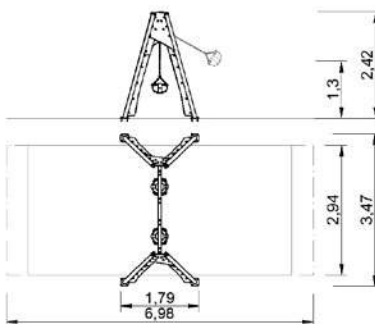

**Columpio Tribox mixto**  
 Mixed Tribox swing  
 Portique Tribox mixte

**R4110M**

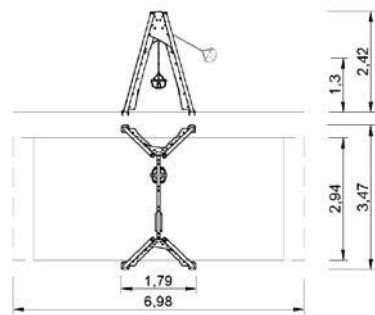

**Columpio Tribox mixto integración cuna**  
 Inclusive cradle mixed Tribox swing  
 Portique Tribox d'intégration mixte siège bébé

**R4110MCD**

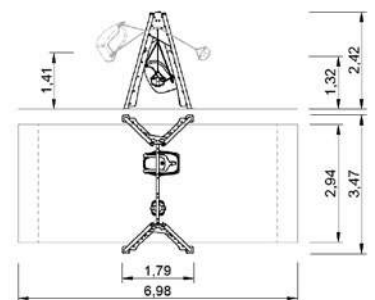

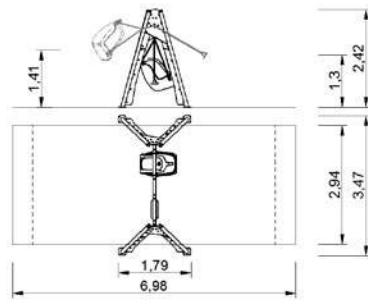

**Columpio Tribox integracion mixto**  
 Inclusive mixed Tribox swing  
 Portique Tribox d'intégration mixte

**R4110MD**

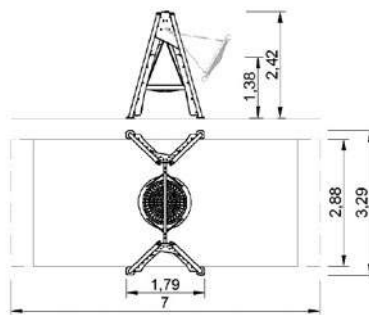

**Columpio nido Tribox**  
 Nest Tribox swing  
 Portique nid Tribox

**R4112**

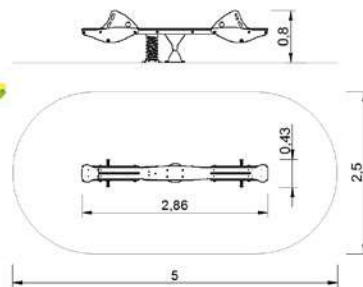

**Los Tiburonicines**  
 The Little Sharks  
 Petits Requins

**R4010**

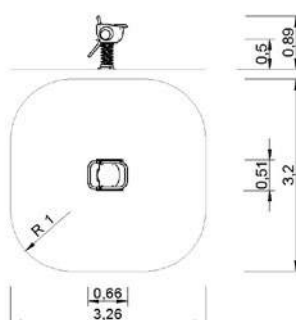

**Muelle de integracion**  
 Inclusive spring rider  
 Jeu à ressort d'intégration

**R4613**





**Los caracoles**

The snails  
 Les escargots

**R4616**

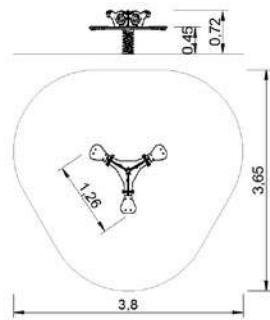

**Muelle Doble Ladybug**

Ladybug  
 Ladybug

**R4617**

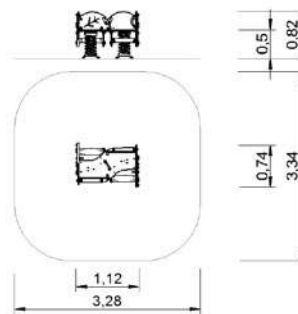

**El Perro**

The Dog  
 Le Chien

**R4650**

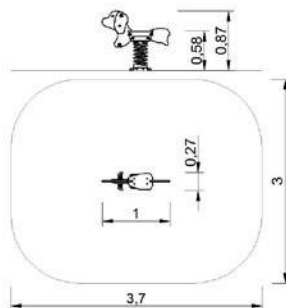

**El Pececito**

Little Fish  
 Le Petit Poisson

**R4665**

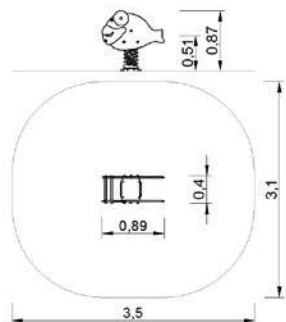

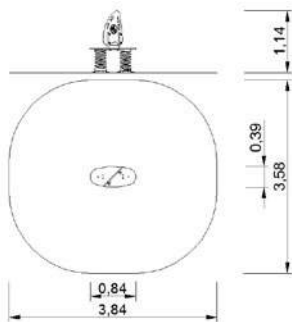

**La Vela**  
 The Little Sail  
 La Planche à Voile

**R4672**

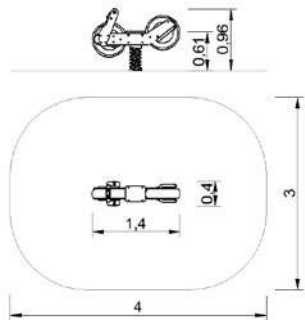

**La gran moto**  
 Big motorbike  
 La grande moto

**R4620**

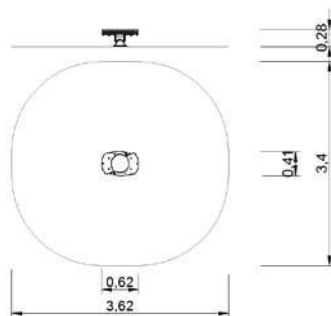
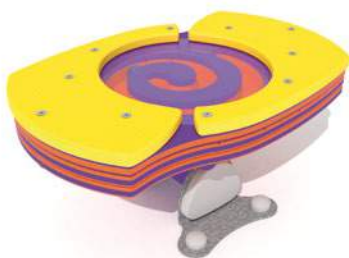

**El Surf**  
 The Surfboard  
 Le Surf

**R4700**

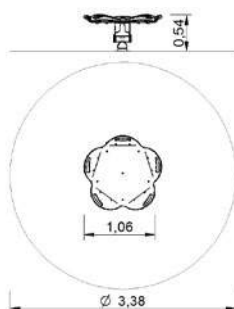

**El Girasol**  
 Sunflower  
 Le Tournesol

**R4705**





**Triple Surf**  
 Triple Surf  
 Le Triple Surf

**R4710**

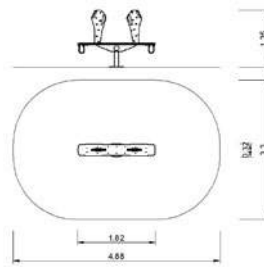

**Burbujas**  
 Bubbles  
 Les Bulles

**R4715**

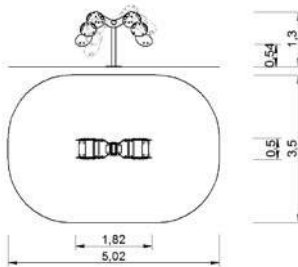

**La Estrella**  
 The Star  
 L'Étoile

**R4725**

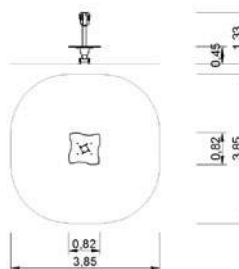

**Carrusel los arcos**  
 The Archs Carousel  
 Manège les Arcs

**R4501**

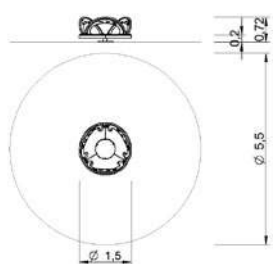



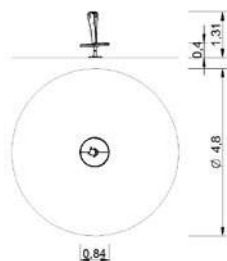

**Carrusel la Peonza**  
 Spinning Carousel  
 Manège la Toupie

**R4504**

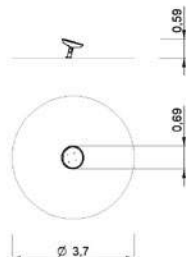

**Carrusel Bowl**  
 Bowl Carousel  
 Manège Bowl

**R4505**

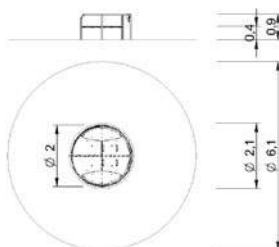

**Carrusel para Todos**  
 Carousel for All  
 Manège pour Tous

**R4507**

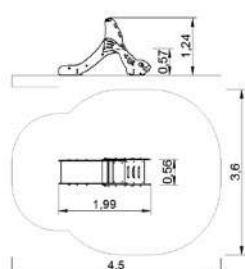

**Tobogán el Pecesito**  
 The Little Fish Slide  
 Toboggan Le Petit Poisson

**R4808**





**Tobogán Tribox**  
 Tribox Slide  
 Toboggan Tribox

**R4824**

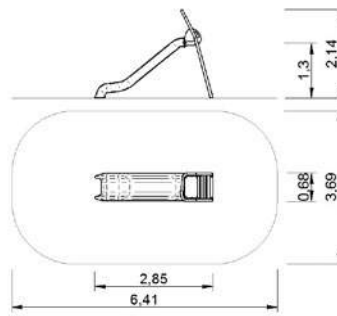

**El Alpinista**  
 Mountain-Climber  
 L'Alpiniste

**R4826**

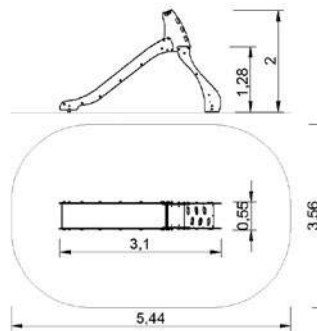

**Casita Tienda**  
 The Store  
 La Boutique

**R5015**

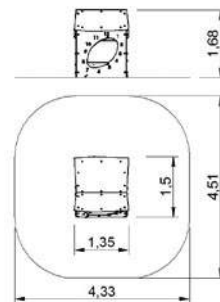

**El Oso**  
 The Bear  
 L'Ours

**R4960**

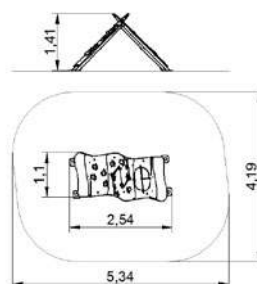

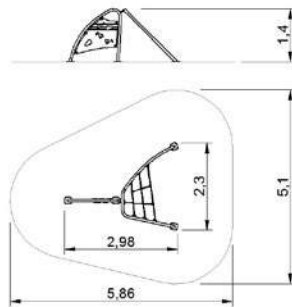

**El Trepador**  
 Climber  
 Le Grimpeur

**R4962**

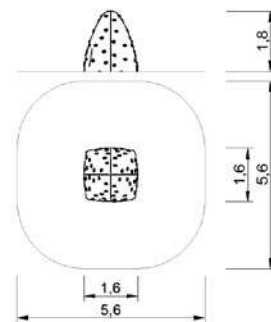

**Rocódromo Infantil**  
 Kids Climbing Rock  
 Structure d'escalade pour Enfants

**R4963**

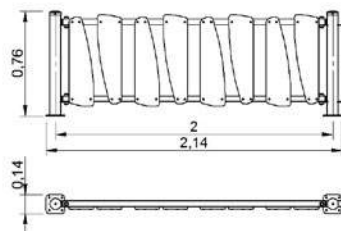

**Valla infantil Tribox**  
 Playground area fence Tribox  
 Clôture aire de jeux Tribox

- Postes en acero galvanizado y lamas de polietileno
- Galvanized Steel posts and HDPE slats
- Poteaux en acier galvanisé et lames en polyéthylène

**R3538**

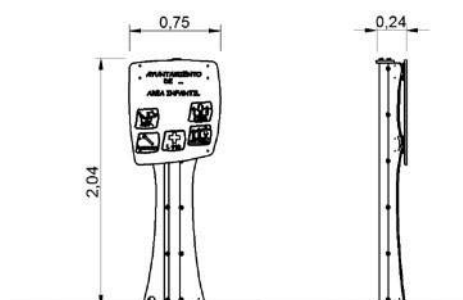

**Cartel Tribox**  
 Tribox sign  
 Panneau d'information Tribox

**R3614**





### Tribox para todos

Tribox for all  
 Tribox pour tous

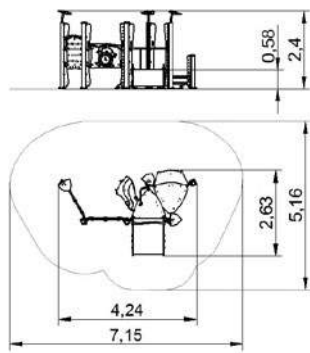

R4275



### Tribox Minidelta

Minidelta Tribox  
 Tribox Minidelta

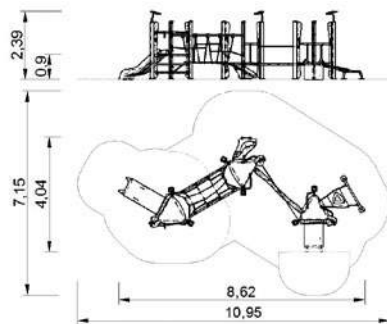

R4285P/R4285X



### Tribox Funambulista

Tightrope Walker Tribox  
 Tribox pour Équilibristes

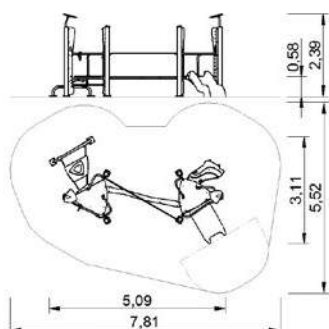

R4286P/R4286X

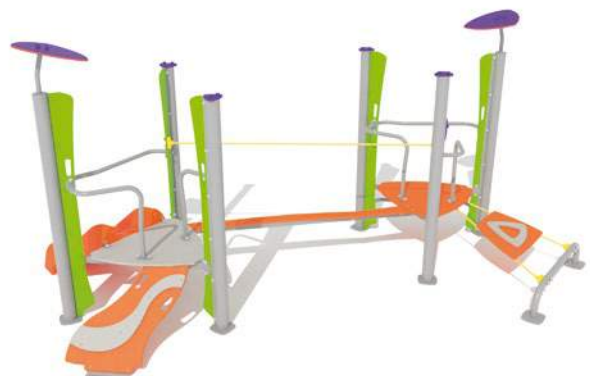



**Tribox Gran Gateador**  
 Big Crawling Tribox  
 Tribox Grand Tunnel à Ramper

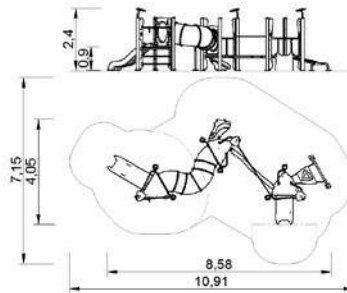

**R4287P/R4287X**



**Tribox Gateador**  
 Crawling Tribox  
 Tribox Tunnel à Ramper

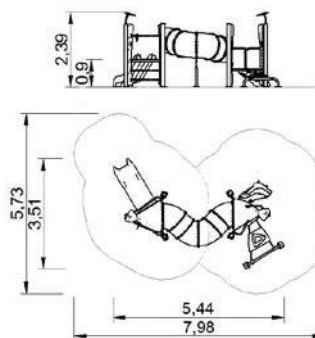

**R4288P/R4288X**



**Tribox Los Gemelos**  
 Twin Tribox  
 Tribox Les Jumeaux

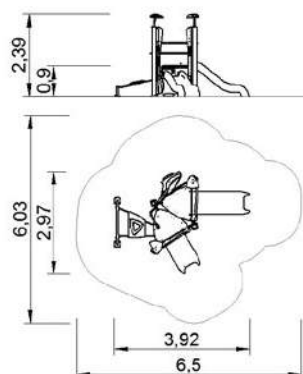

**R4289P/R4289X**





**Tribox Compacto**  
 Compact Tribox  
 Tribox Compact

**R4291P/R4291X**

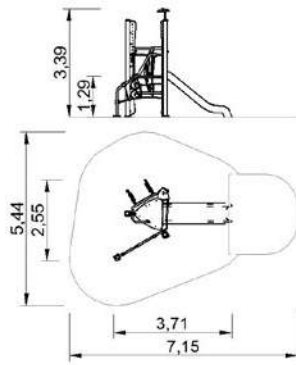

**Tribox Tornado**  
 Spinning Tribox  
 Tribox Tourbillon

**R4292P/R4292X**

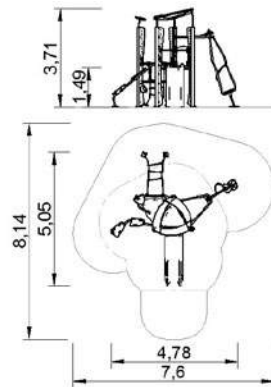

**Tribox Araña**  
 Spyder Tribox  
 Tribox Toile d'araignée

**R4293P/R4293X**

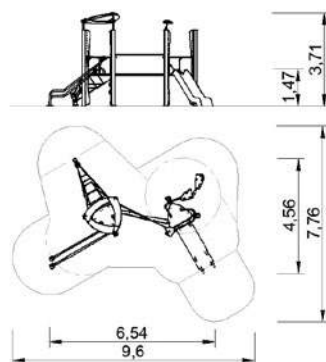



**Tribox Colgante**  
 Dangling Tribox  
 Tribox Pont Suspendu

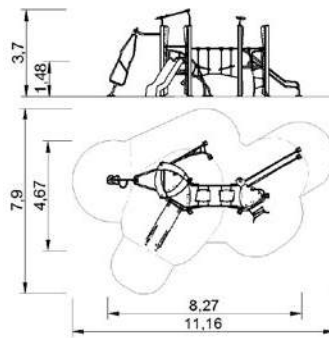

**R4294P/R4294X**



**Tribox Delta**  
 Delta Tribox  
 Tribox Delta

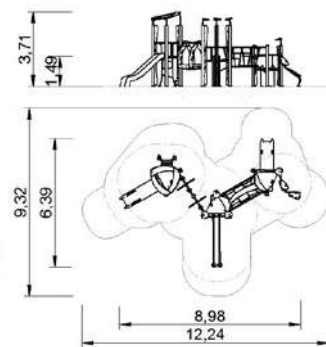

**R4295P/R4295X**



**Tribox Escalador**  
 Rocking Tribox  
 Le Tribox Alpiniste

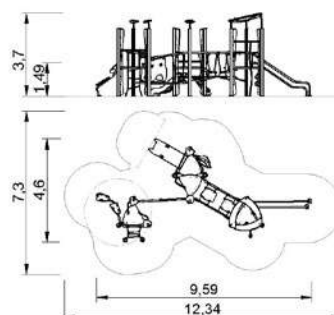

**R4296P/R4296X**





**Tribox Todo En Uno**  
 All-In-One Tribox  
 Tribox Tout-En-Un

**R4297P/R4297X**

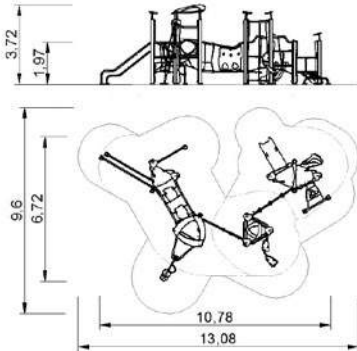

**Tribox Zig-Zag**  
 Zig-Zag Tribox  
 Tribox Zig-Zag

**R4298P/R4298X**

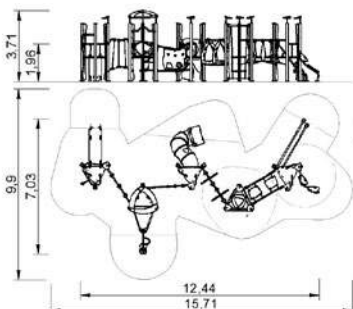





**Tribox Gigante**  
 Giant Tribox  
 Le Tribox Géant

**R4299P/R4299X**

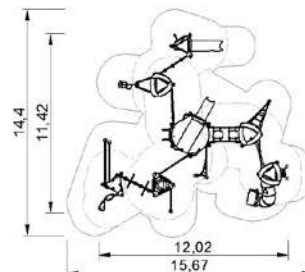

**Mediterraneum Tribox**  
 Mediterraneum Tribox  
 Mediterraneum Tribox

**R4268P/R4268X**  
**R4268NX**

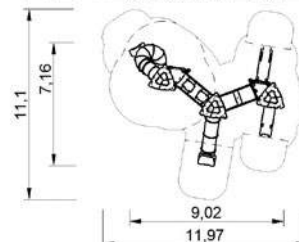









# Juga :)

## Serie Juga Juga Series Série Juga

### QUÉ ES JUGA?

Para un niño, jugar es tan importante como alimentarse. El niño que no juega es un niño que no se desarrolla plenamente...”

Tras un profundo trabajo de investigación sobre las etapas de desarrollo del niño a través del juego, con ayuda de especialistas en psicomotricidad y educación infantil, un grupo de arquitectos y diseñadores ha creado JUGA: una nueva línea de juegos infantiles para el espacio público.

Esta nueva línea de mobiliario urbano se formaliza a través de un sistema geométrico que construye paisajes abiertos a la libre interpretación del niño. Dicho sistema se basa en la repetición de una única pieza que forma distintas figuras geométricas según su número, potenciando la capacidad espacial de los niños.

Un parque diseñado con JUGA genera un entorno rico y novedoso: un espacio simbólico sugerente donde experimentar a través del juego.

Cada elemento o “JUGA” integra varias etapas de desarrollo en un mismo diseño, de forma que, según su edad, el niño trabaja la etapa psicomotriz en la que se encuentra. Este aspecto permite que niños de varias edades experimenten fases de desarrollo diferentes en un mismo juego.

JUGA es un sistema abierto a futuras incorporaciones que seguro enriquecerán y completarán los juegos ya existentes.

### WHAT IS JUGA?

“For a child, playing is as important as eating. The child who does not play is a child who does not fully develop...”

Following thorough research into the stages of children’s development through play, with the help of specialists in motor skills and child education, a group of architects and designers has created JUGA: a new line of children’s playgrounds for public spaces.

This new line of street furniture is composed of a geometric system used to form landscapes that are open to be freely interpreted by children. This system is based on the repetition of a single piece that creates various geometric figures according to their number, encouraging children’s spatial abilities.

A playground designed using JUGA creates a rich, novel environment: a suggestive symbolic space where children can experiment through play.

Each component, or “JUGA”, integrates various stages of development in a single design, so that, according to their age, children can exercise the psychomotor stage they are currently in. This aspect enables children of various ages to explore different stages of development in the same playground.

The JUGA system is open to future additions that will, without doubt, enhance and develop the existing games.

### C’EST QUOI JUGA ?

“Pour un enfant, le jeu est aussi important que de s’alimenter. L’enfant qui ne joue pas est un enfant qui ne se développe pas pleinement ...”

Après une recherche approfondie sur les étapes de la croissance de l’enfant par le jeu et avec l’aide de spécialistes de la motricité et de l’éducation, un groupe d’architectes et de designers ont créé une nouvelle gamme de jeux JUGA: Une nouvelle série de jeux pour enfants pour les lieux publics.

Cette nouvelle ligne de mobilier urbain prend forme par un système géométrique qui crée des paysages offerts à l’imagination de l’enfant. Les formes géométriques sont constituées d’une unique pièce qui se répète selon les différentes figures stimulant la notion d’espace chez l’enfant. Un parc conçu avec JUGA offre un environnement riche et original: un espace symbolique et inspirant pour expérimenter de manière ludique.

Chaque élément ou « JUGA » intègre plusieurs étapes du développement dans un même design, de la sorte que selon son âge l’enfant travaille l’étape psychomotrice dans lequel il se trouve.

Cet aspect permet que les enfants de divers âges expérimentent les différentes phases de développements dans un même jeu.

JUGA est un système ouvert permettant l’ajout de nouveaux éléments qui certainement enrichiront et compléteront les jeux existants.



Galería de fotos  
Photo gallery  
Galerie de photos



PARQUES INFANTILES / PLAYGROUND EQUIPMENT / JEUX D'EXTÉRIEUR  
SERIE **JUGA** / **JUGA** SERIES / **SÉRIE JUGA**



R4100



R4100C



R4100M

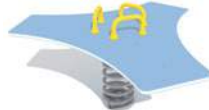

R4678



R1160



R3539



R3615



R5301



R5302

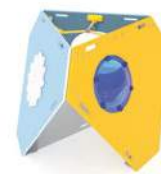

R5303



R5305

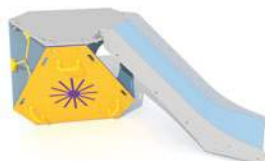

R5304



R5306



R5307



R5308



R5309



R5310



R5311

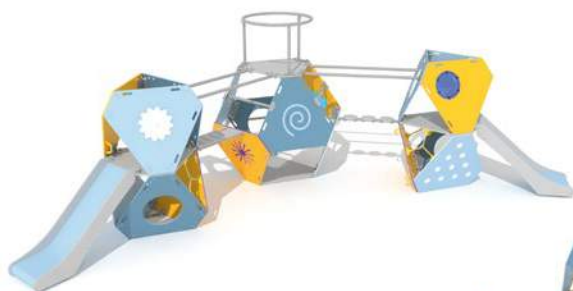

R5312

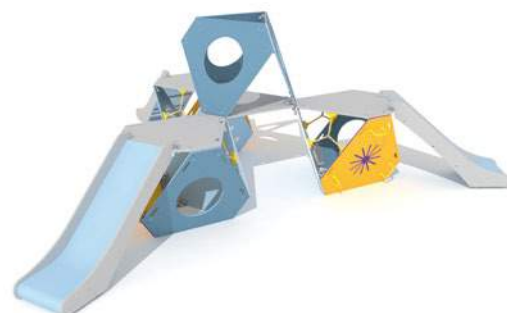

R5313

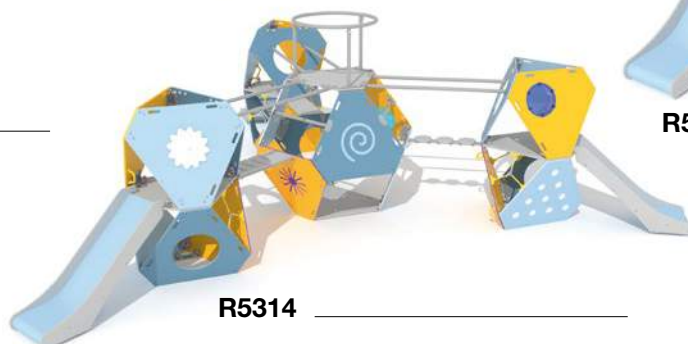

R5314

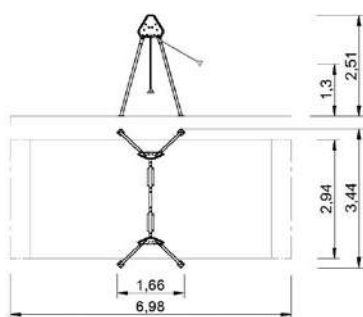

**Columpio Juga**  
 Juga swing  
 Portique Juga

**R4100**

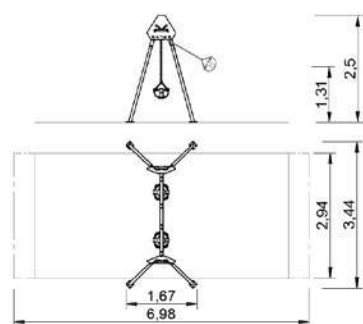

**Columpio Juga con asientos cuna**  
 Juga swing with cradle seats for babies  
 Portique Juga avec sièges de sécurité

**R4100C**

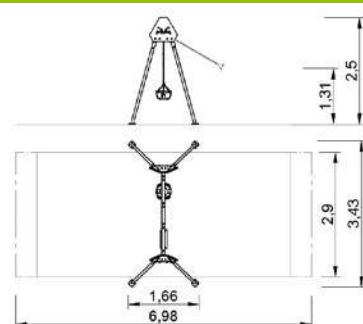

**Columpio Juga mixto**  
 Mixed Juga swing  
 Portique Juga mixte

**R4100M**

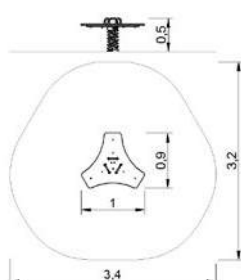
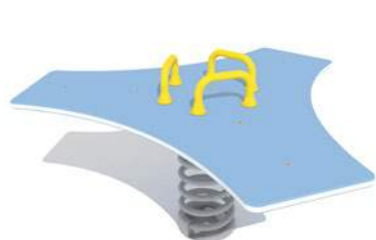

**Muelle Juga**  
 Juga spring rider  
 Jeu à ressort Juga

**R4678**





**Banco Juga**  
 Juga bench  
 Banc Juga

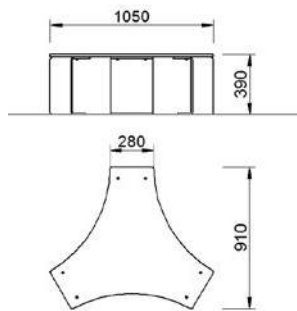

R1160

**Valla Juga**  
 Juga fence  
 Clôture aire de jeux Juga

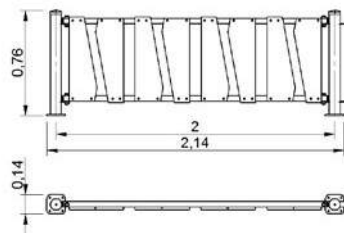

Postes en acero galvanizado y lamas de polietileno  
 Galvanized Steel posts and HDPE slats  
 Poteaux en acier galvanisé et lames en polyéthylène

R3539

**Cartel Juga**  
 Juga playground area sign  
 Panneau d'information Juga

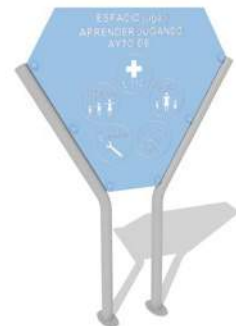
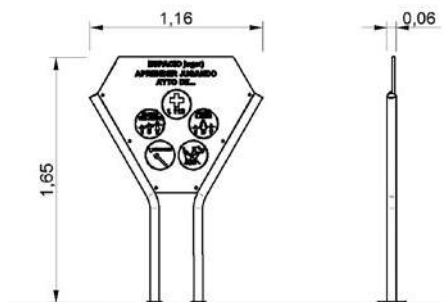

R3615

**Juga túnel gateador**  
 Crawling tunnel Juga  
 Juga tunnel à ramper

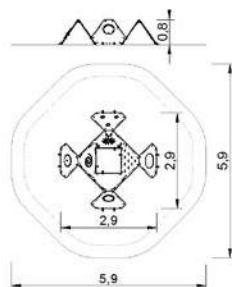

R5301





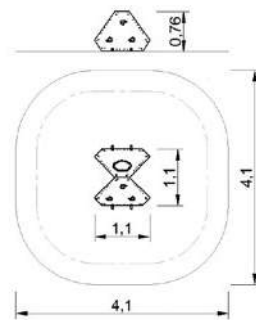

**Juga tienda de campaña**  
 Tent Juga  
 Juga tente

**R5302**

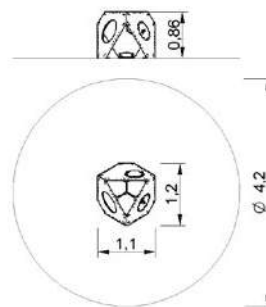

**Juga cabaña**  
 Cottage Juga  
 Juga cabane

**R5303**

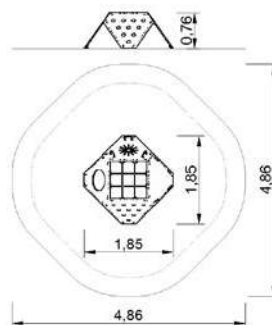
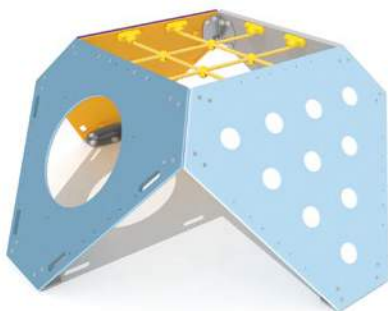

**Juga tela de araña**  
 Spider web Juga  
 Juga toile d'araignée

**R5305**

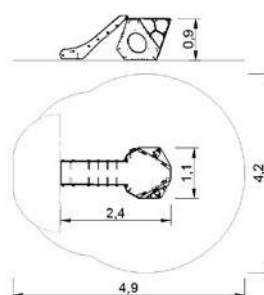
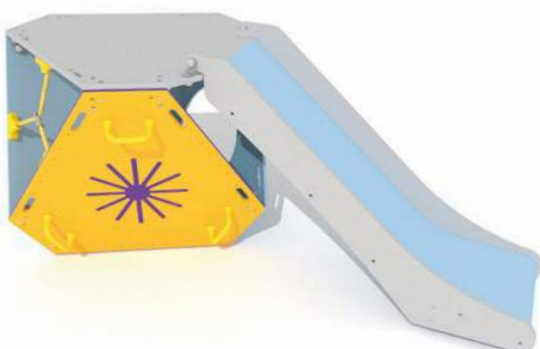

**Juga roca**  
 The rock Juga  
 Juga roche

**R5304P / R5304X**





**Juga rey de la colina**  
 King of the hill Juga  
 Juga roi de la colline

**R5306**

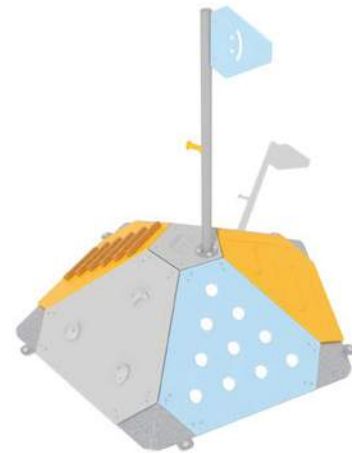
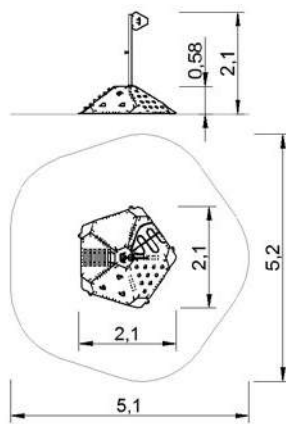

**Juga boca de dragón**  
 Dragon's mouth Juga  
 Juga bouche de dragon

**R5307P / R5307X**

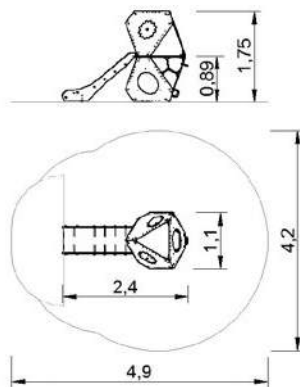

**Juga 6 puertas**  
 Six-door Juga  
 Juga 6 portes

**R5308**

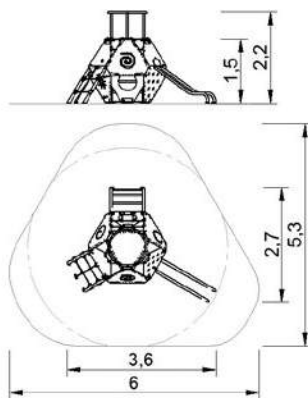

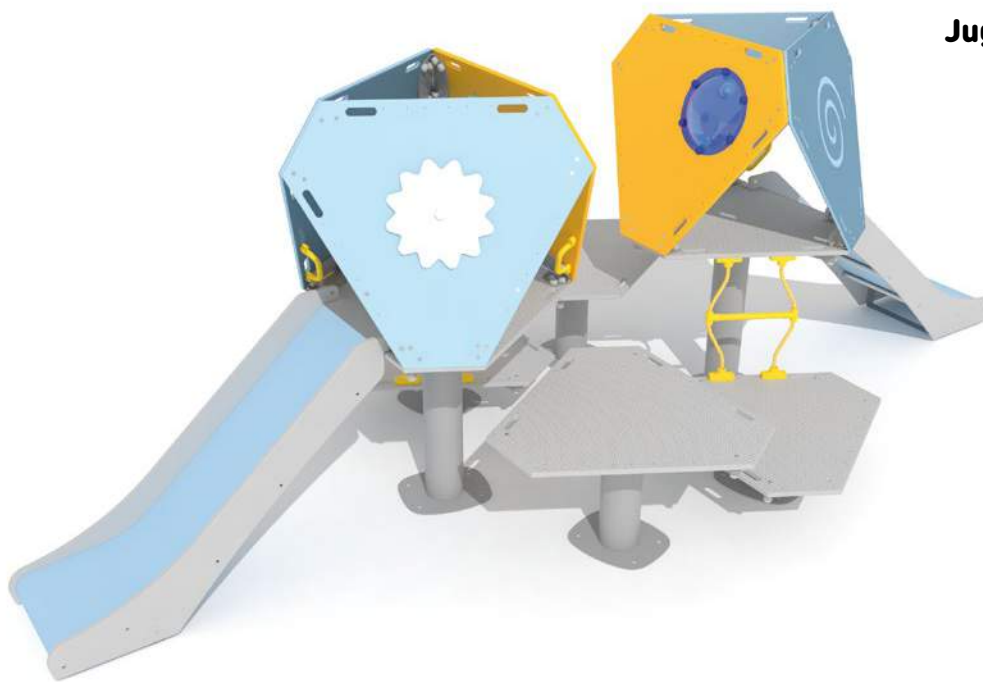

**Juga camino de los duendes**  
 Fairy trail Juga  
 Juga chemin des lutins

**R5309P / R5309X**

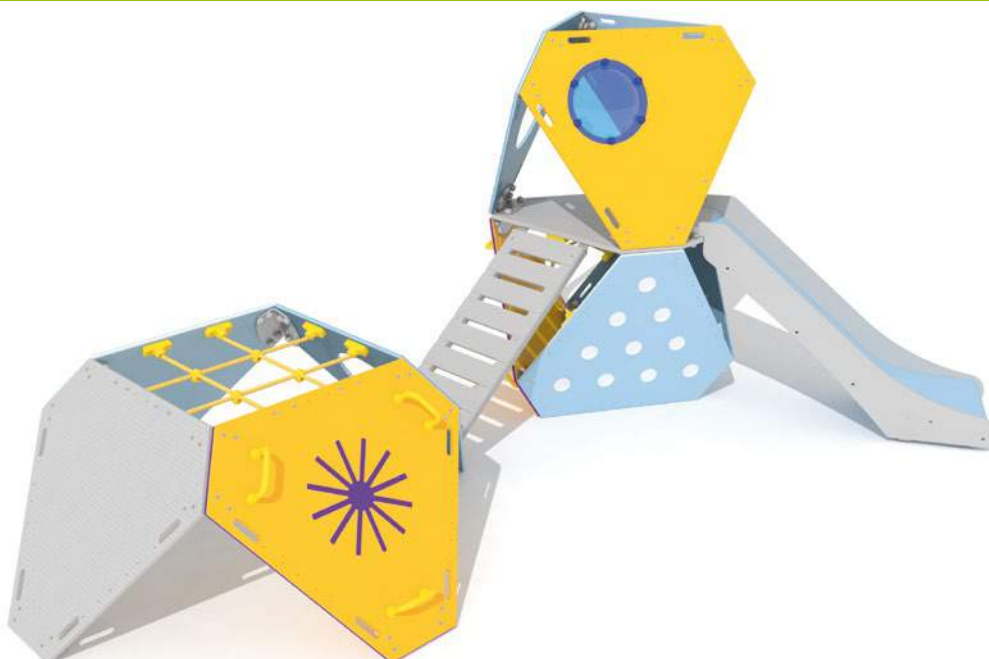
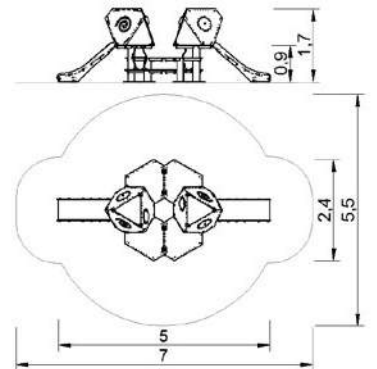

**Juga tortuga**  
 Turtle Juga  
 Juga tortue

**R5311P / R5311X**

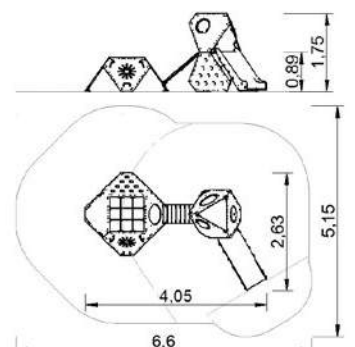



**Juga nave espacial**  
 Spaceship Juga  
 Vaisseau spatial Juga

**R5310P / R5310X**

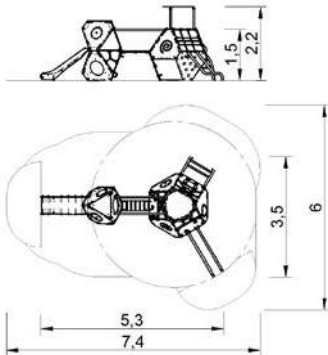

**Juga cangrejo**  
 Crab Juga  
 Juga crabe

**R5312P / R5312X**

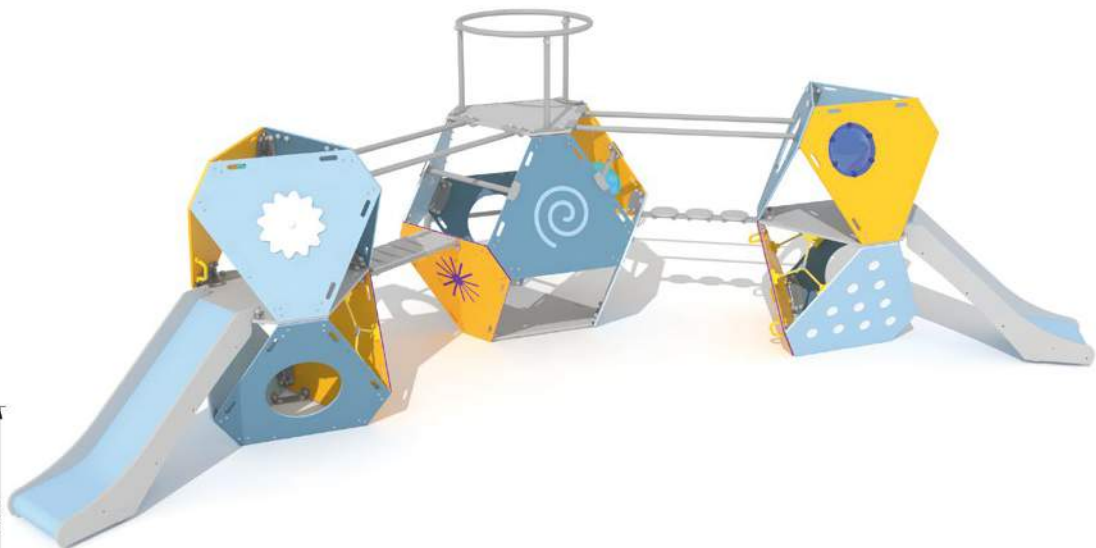
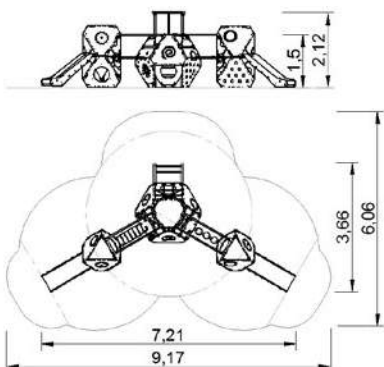

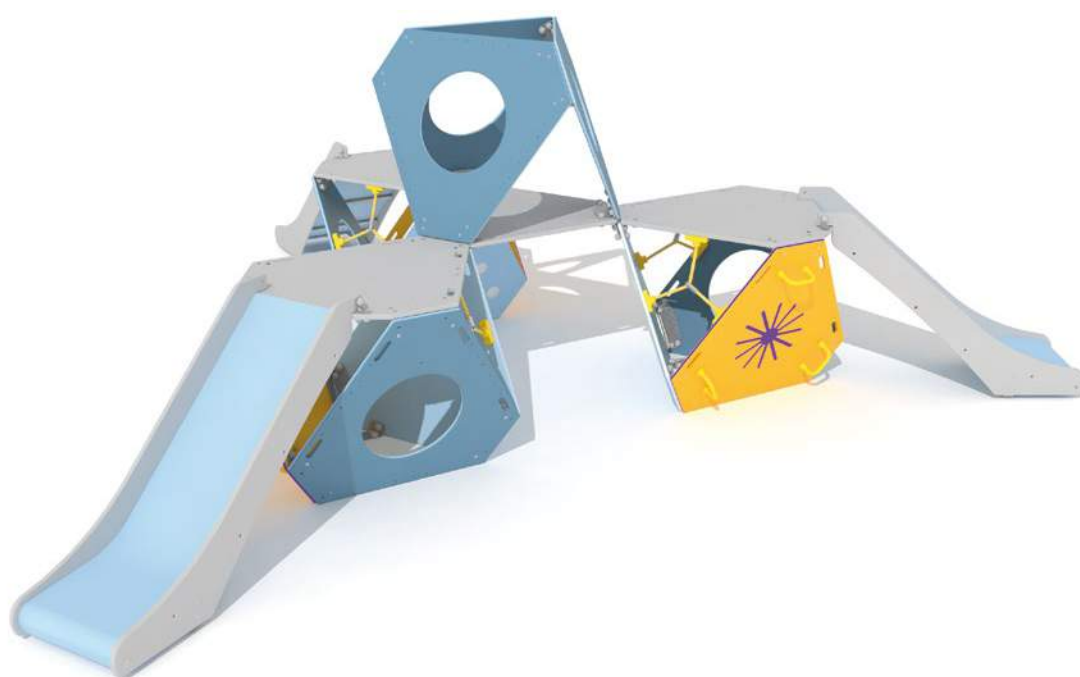

**Juga laberinto 3D**  
 3D labyrinth Juga  
 Juga labyrinthe 3D

**R5313P / R5313X**

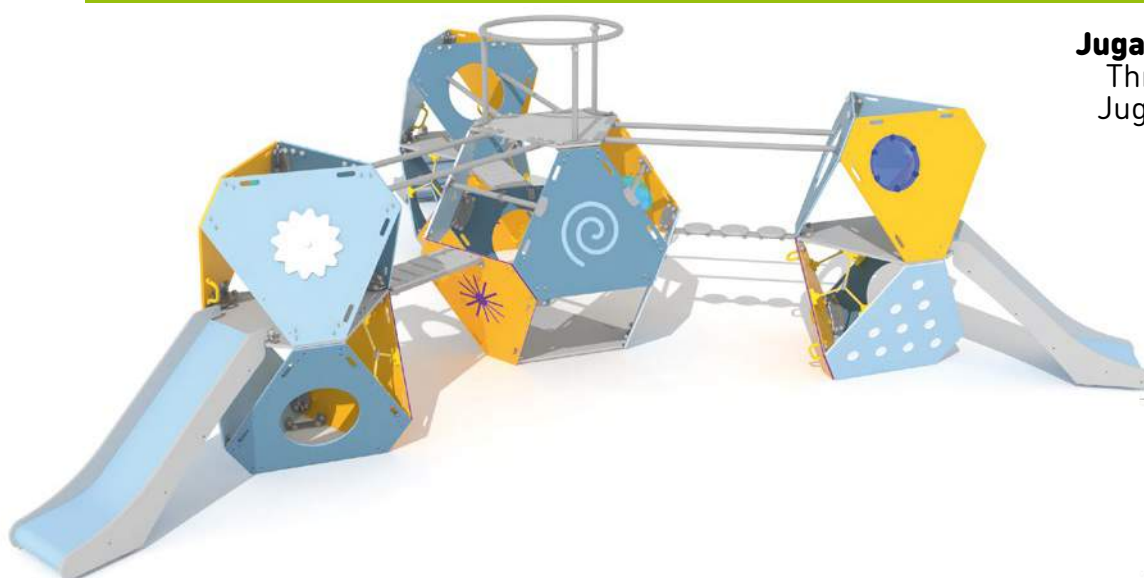
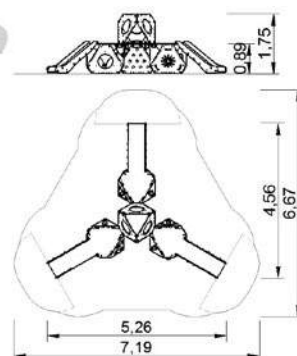

**Juga dragón de 3 cabezas**  
 Three head dragon Juga  
 Juga dragon à trois têtes

**R5314P / R5314X**

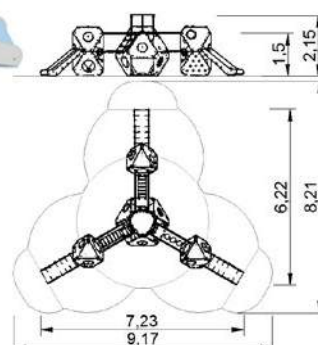

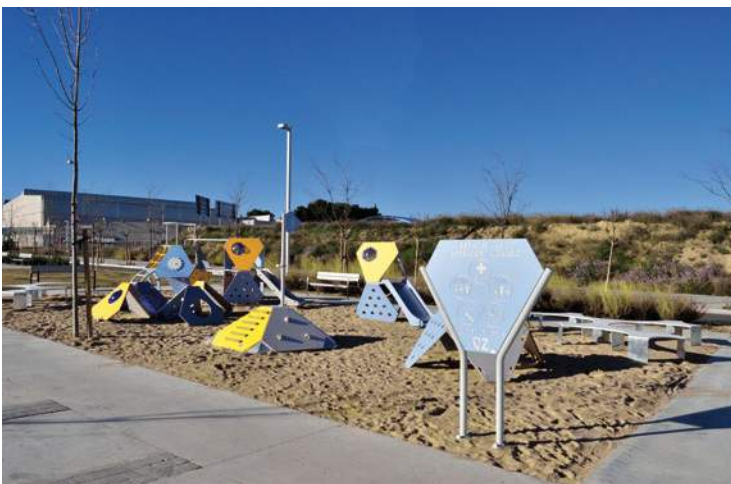









# Serie Veleta

## Veleta Series

## Série Veleta



### SERIE VELETA

La Serie Veleta es una completa gama de juegos con una excelente relación calidad-precio. Juegos infantiles de diseño y fabricación propia, 100% europeos.

Elija entre una amplia gama de estructuras de juego, balanzas, juegos de muelle, toboganes, columpios y carruseles. Todos con nuestra calidad de siempre, al mejor precio.

En las estructuras de juego Veleta para niños pequeños se incorporan paneles educativos en inglés para un mayor valor lúdico y educativo del juego.

### VELETA SERIES

The VELETA Series is a complete range of activities with excellent value for money. We design and manufacture the playgrounds ourselves, they are 100% European.

Choose from a wide range of play structures, seesaws, spring riders, slides, swings and roundabouts. All meet our usual high standards of quality, at the best price.

In the play structures for toddlers, Veleta incorporates educational panels in English to bring added fun and educational value to their play

### SÉRIE VELETA

La Série VELETA est une gamme complète de jeux d'une excellente relation qualité-prix. Jeux pour enfants de propres design et fabrication, 100% européens.

Choisissez parmi une ample gamme de structures de jeux, bascules, jeux à ressort, toboggans, balançoires et carrousels, dont la qualité n'a jamais été démentie jusqu'à ce jour, au meilleur prix.

Les structures de jeu Veleta pour les petits enfants incluent des panneaux éducatifs en anglais pour une plus grande valeur ludique et éducative.



Galería de fotos  
Photo gallery  
Galerie de photos



PARQUES INFANTILES / PLAYGROUND EQUIPMENT / JEUX D'EXTÉRIEUR  
SERIE VELETA / VELETA SERIES / SÉRIE VELETA



R4139



R4139C



R4139M



R4139MCD



R4139MD



R4141



R4310



R4030



R4608



R4612



R4625



R4650



R4635



R4640



R4645



R4660



R4674



R4675



R4680



R4681



R4682



R4683



R4502



R5050



R5005



R5008



R5021



R5024



R5025



R5028



R4812



R4815



R4823



R3611



R3532



R4279



R4206



R4207



R4208



R4209



R4210



R4222



R4218



R4221



R4223



R4219



R4220



R4217



**Columpio Veleta**  
 Veleta swing  
 Portique Veleta

**R4139**

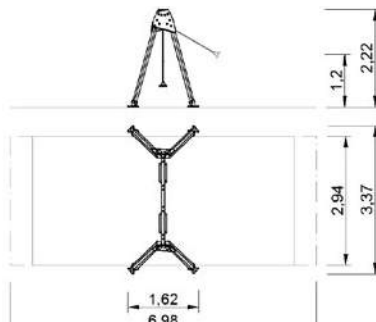

**Columpio Veleta con asientos cuna**  
 Veleta swing with cradle  
 seats for babies  
 Portique Veleta avec  
 sièges de sécurité

**R4139C**

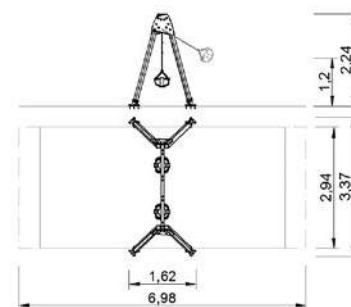

**Columpio Veleta mixto**  
 Mixed Veleta swing  
 Portique mixte Veleta

**R4139M**

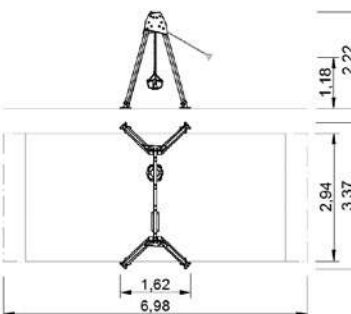

**Columpio Veleta mixto integración cuna**  
 Inclusive cradle mixed Veleta swing  
 Portique Veleta d'intégration  
 mixte siège bébé

**R4139MCD**

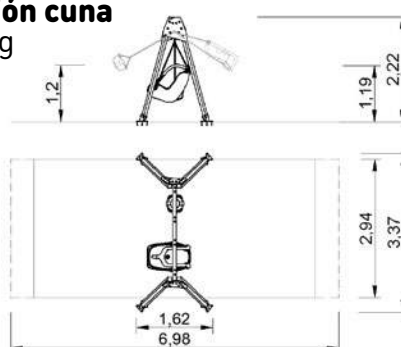

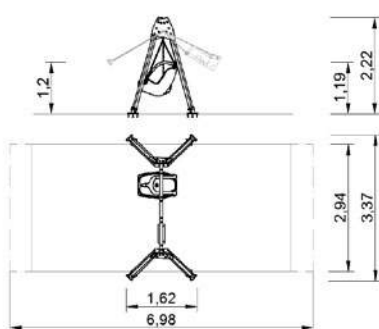

**Columpio Veleta integracion mixto**  
 Inclusive mixed Veleta swing  
 Portique Veleta d'intégration mixte

**R4139MD**

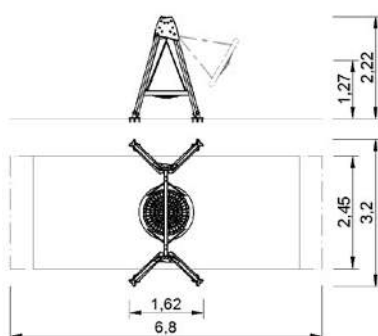

**Columpio Veleta nido**  
 Nest Veleta swing  
 Portique nid Veleta

**R4141**

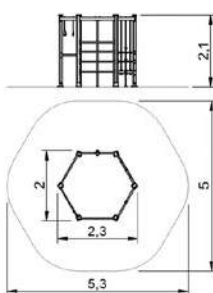

**Estructura Hexagonal para Gimnasia**  
 Hexagonal Shaped Monkey Bars  
 Structure à Agrès Hexagonale

**R4310**

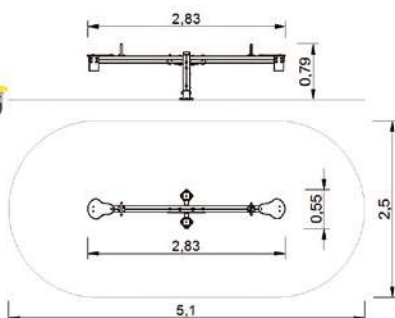

**Muelle de integracion**  
 Inclusive spring rider  
 Jeu à ressort d'intégration

**R4030**





**El Fantasmilla**  
 The Little Ghost  
 Le petit Fantôme

**R4608**

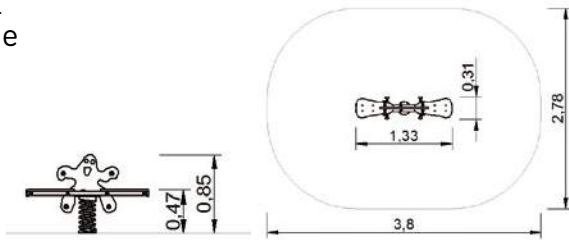

**Las Nubes**  
 The Clouds  
 Les Nuages

**R4612**

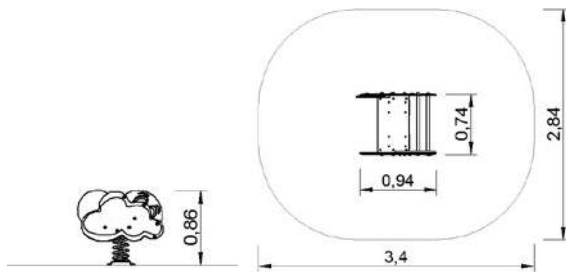

**El Turbin**  
 Little Car  
 Le Cabriolet

**R4625**

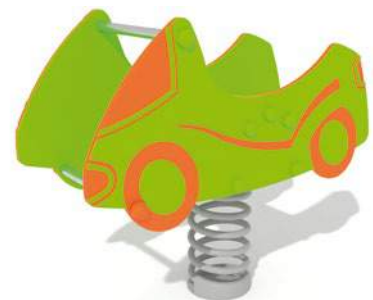
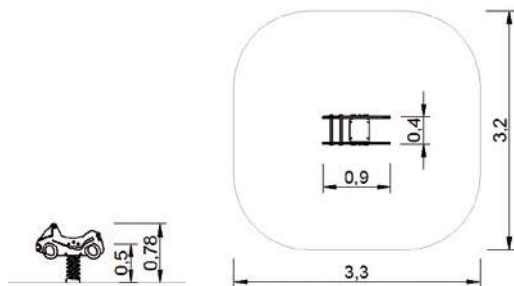

**El Perro**  
 The Dog  
 Le Chien

**R4650**

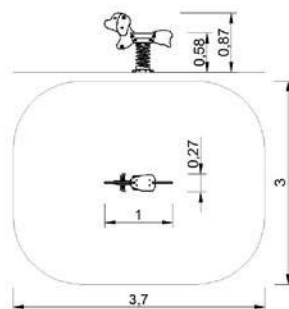

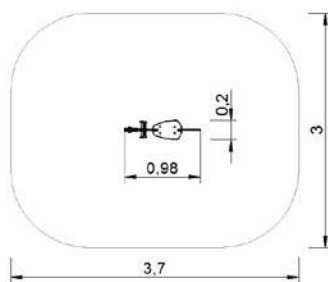

**El Mosquito**  
 Mosquito  
 Le Moustique

**R4635**

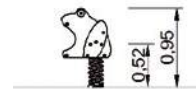
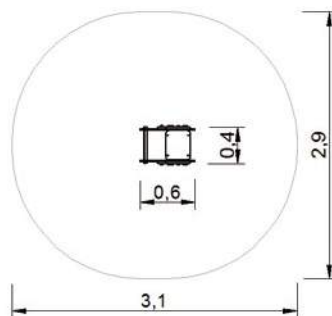

**La rana**  
 The frog  
 La grenouille

**R4640**

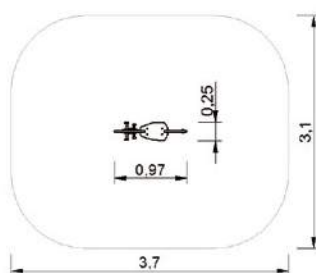

**El avion**  
 The plane  
 L' avion

**R4645**

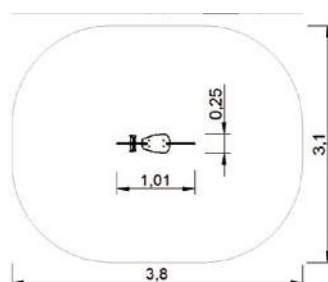

**La motocicleta**  
 Motorbike  
 La motocyclette

**R4660**





**Mundi**  
 The world  
 Le monde

**R4674**

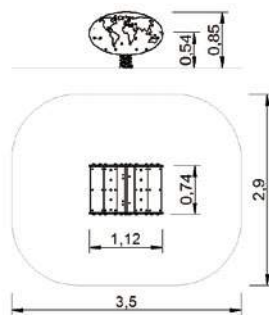

**El platillo volante**  
 Flying Saucer  
 La Soucoupe Volante

**R4675**

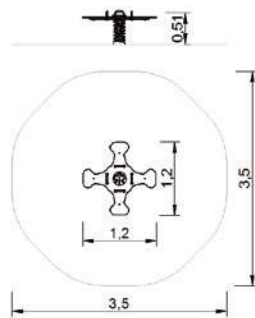

**El Lóbulo**  
 The Lobe  
 Le Lobe

**R4680**

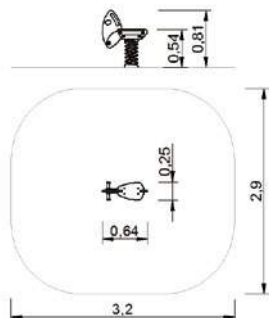

**El Boomerang**  
 The Boomerang  
 Le Boomerang

**R4681**

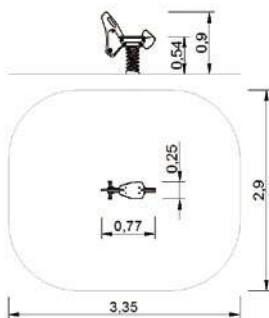



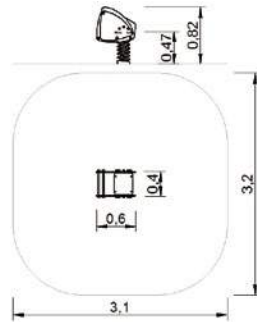

**Pétalos**  
 Petals  
 Les Pétales

**R4682**

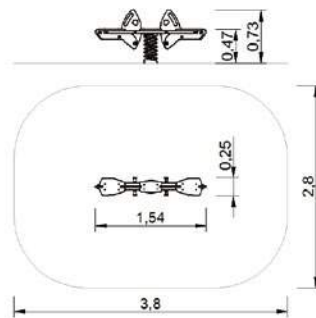
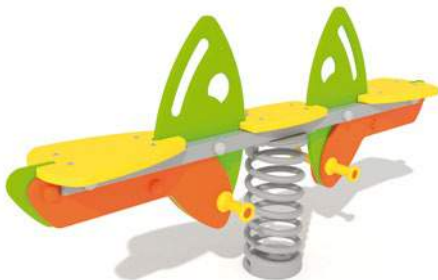

**Lóbulo Doble**  
 Double Lobe  
 Lobe Double

**R4683**

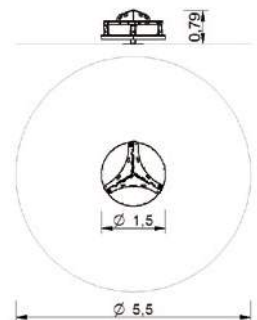

**Carrusel Volador**  
 Flying Carousel  
 Manège Volant

**R4502**

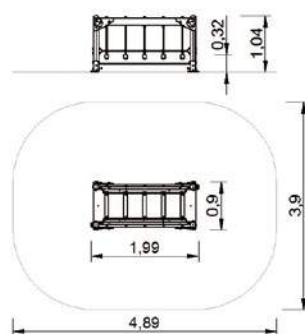
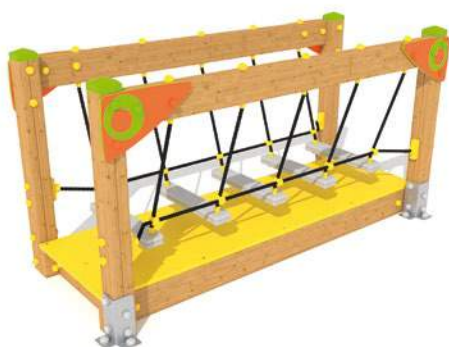

**Puente Flotante**  
 Floating bridge  
 Pont Flottant

**R5050**





**El Tren**  
 Big Train  
 Le Train

**R5005**



También elementos sueltos  
 Also individual items  
 Vendu aussi séparément

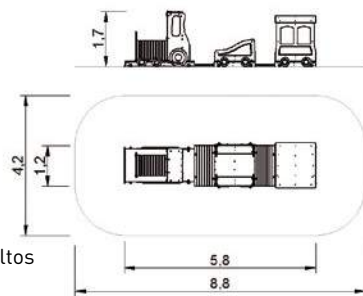

**La Cosechadora**  
 The Harvester  
 La Moissonneuse-Batteuse

**R5008**

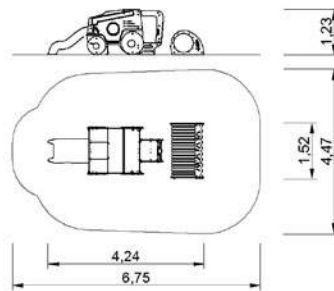

**Casita**  
 Little House  
 Petite Maison Meublée

**R5021**



**Casita Veleta**  
 Veleta Little House  
 Maisonnée Veleta

**R5024**

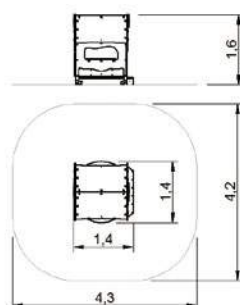



**La Gran Casita**  
 Big House  
 Maisonnette Multijeux

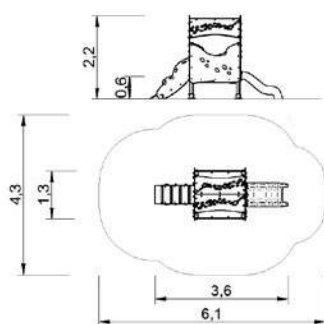

**R5025**



**Mesita Veleta**  
 Veleta Table  
 Table Veleta

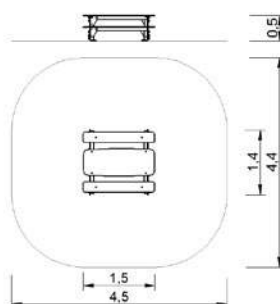

**R5028**



**Tobogán dinosaurio**  
 Dinosaur Slide  
 Toboggan Dinosaur

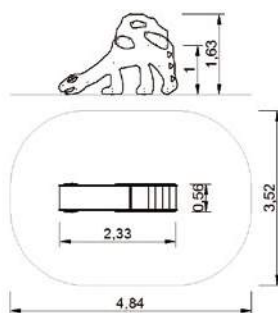

**R4812**



**Tobogán Elefante**  
 Elephant Slide  
 Toboggan Éléphant

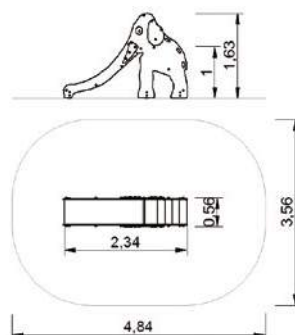
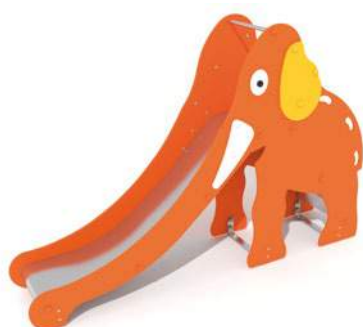

**R4815**





**Tobogán Saltarín**  
 Jumping Slide  
 Toboggan Le Petit Sauteur

**R4823**

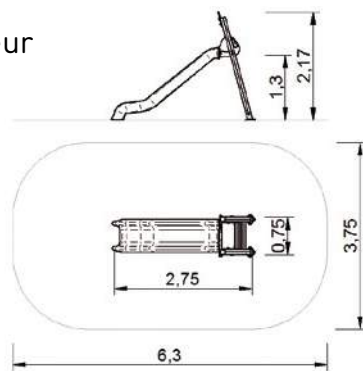

**Valla Veleta**  
 Veleta Fence  
 Clôture Aire de Jeux Veleta

Postes madera tratada y lamas polietileno  
 Treated Wood posts and HDPE slats  
 Poteaux en bois traité et lames en polyéthylène

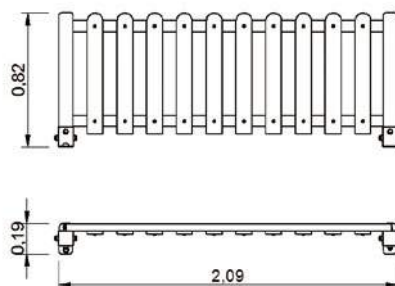

**R3532**

**Cartel Veleta**  
 Veleta Sign  
 Panneau d'information Veleta

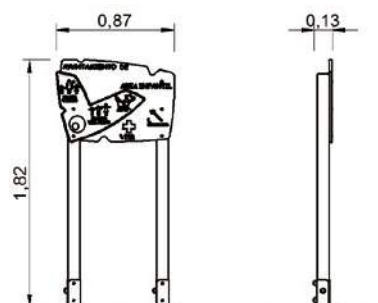

**R3611**



**Parque de Bomberos Veleta**  
 Fire Station Park Veleta  
 La Caserne de Pompiers Veleta

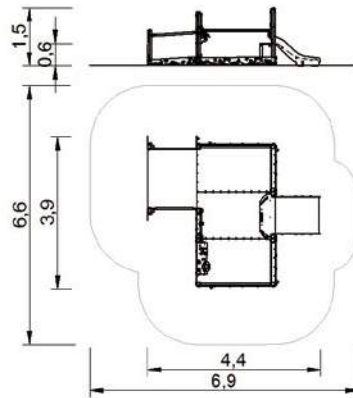
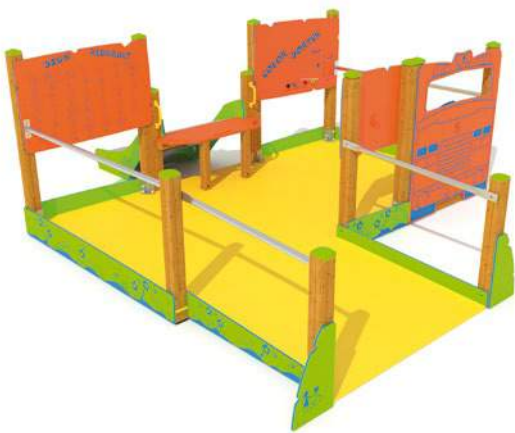

R4279

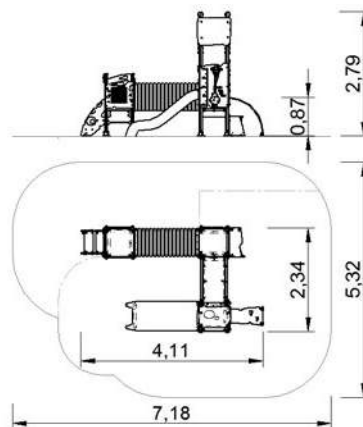

**Veleta oruga**  
 Caterpillar Veleta  
 Veleta Chenille



R4206P / R4206X

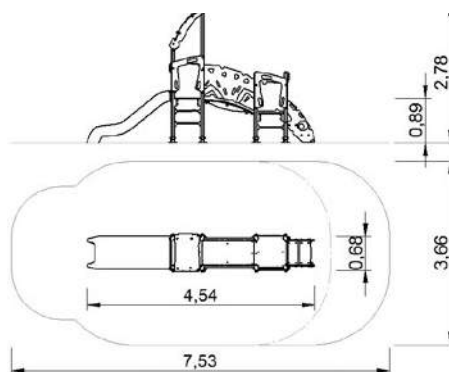

**Veleta en línea**  
 Lined Veleta  
 Veleta en Ligne Droite



R4207P / R4207X





**Veleta Circular**  
 Veleta Go-Round  
 Veleta en Circle



**R4208P / R4208X**

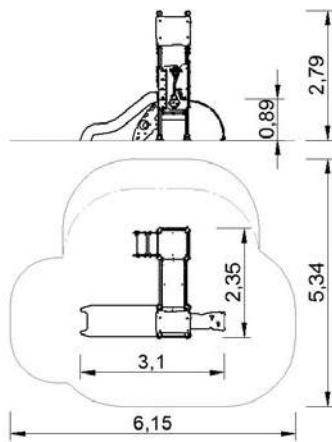

**Veleta gateador**  
 Crawling Veleta  
 Veleta Tunnel à Ramper



**R4209P / R4209X**

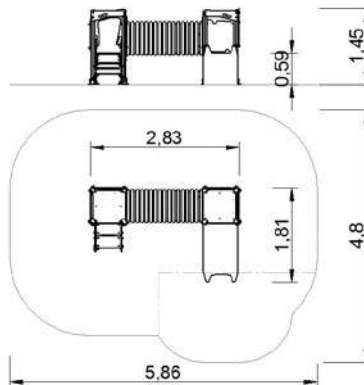

**Veleta tortuga**  
 Turtle Veleta  
 Veleta Tortue



**R4210P / R4210X**

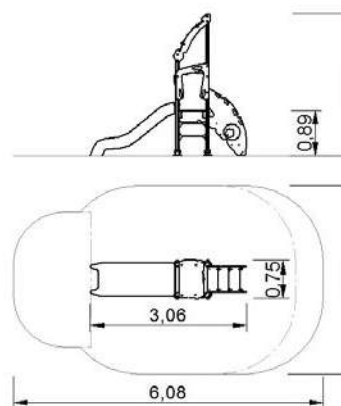



**Multijuego Veleta**  
 Veleta playset  
 Multi-jeux Veleta

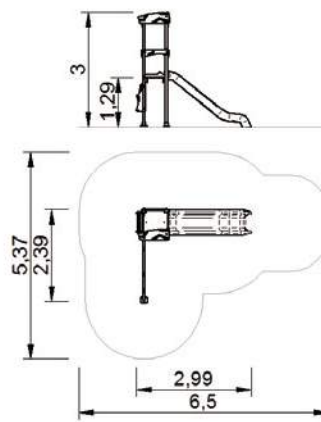

**R4222P / R4222X**



**Veleta volador**  
 Flying Veleta  
 Veleta Volant

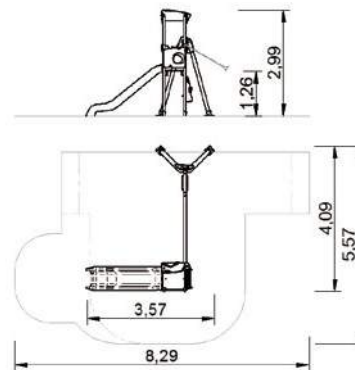

**R4218P / R4218X**



**Multijuego Veleta doble**  
 Double Veleta playset  
 Structure multi-jeux  
 Veleta double

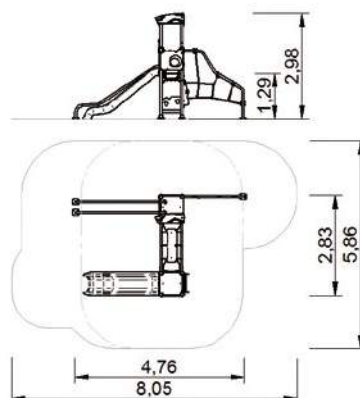

**R4221P / R4221X**





**Multijuego Veleta puente**  
 Bridge Veleta playset  
 Structure multi-jeux Veleta avec pont

**R4223P / R4223X**

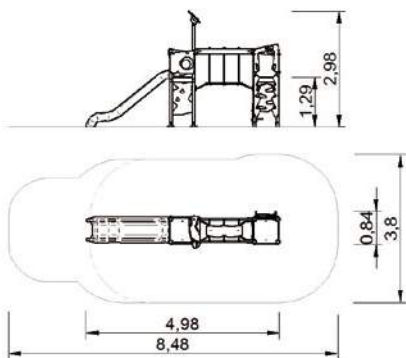

**Multijuego Gran Veleta**  
 Great Veleta playset  
 Structure multi-jeux Grand Veleta

**R4219P / R4219X**

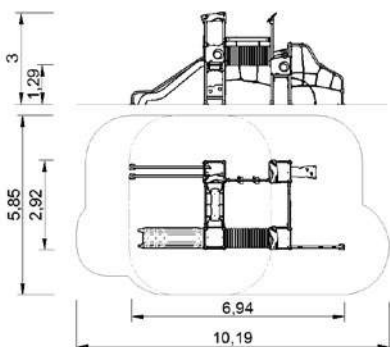





**Multijuego Veleta triple**  
 Triple Veleta playset  
 Structure multi-jeux Veleta triple

**R4220P / R4220X**

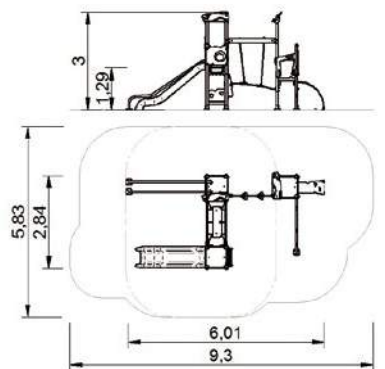

**Multijuego Veleta Seis Torres**  
 Six Towers Veleta Playset  
 Structure Multi-Jeux  
 Veleta Six Tours

**R4217P / R4217X**

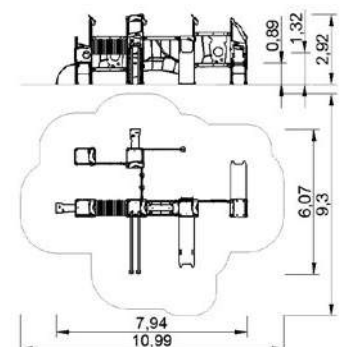



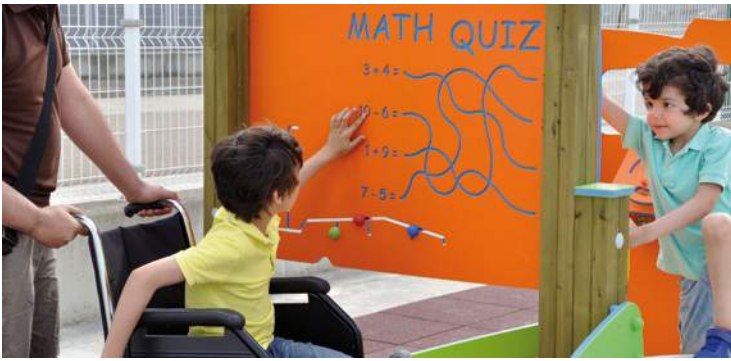

# Serie PLAYKIT

## PLAYKIT Series

### Série PLAYKIT



# PLAYKIT



Juegos infantiles económicos, robustos, fáciles de limpiar y de desinfectar.

Los juegos para áreas infantiles de la Serie Playkit son robustos, resistentes, fáciles de limpiar y de desinfectar. Una serie de juegos infantiles económicos fabricados con materiales de primera calidad y alta resistencia a la intemperie como es el acero galvanizado y el polietileno de alta densidad. Con una proporción de hasta un 60% de plástico reciclado, estos juegos infantiles de temática ambientada en la naturaleza y el universo son medioambientalmente sostenibles.

En la serie Playkit encontramos juegos infantiles tematizados con simpáticos animales como graciosos koalas, escurridizas serpientes, alegres pajarillos o búhos vigilantes. Jugando con los juegos infantiles Playkit podremos descubrir el sistema solar, conocer los astros, aprender las capas de la atmósfera o diferenciar las fases lunares. Los juegos infantiles Playkit han sido diseñados para divertir a los más pequeños en condiciones de seguridad, siendo ideales para proyectos de parques infantiles al aire libre, colegios, comunidades de vecinos y espacios públicos de libre acceso en los que se requiere ajustar el presupuesto.

Low-cost, robust, easy-to-clean and easy-to-disinfect playground equipment.

The Playkit Series playground equipment is robust, resistant, easy to clean and disinfect. A series of low-cost playground equipment made from high-quality, weather-resistant materials such as galvanized steel and high-density polyethylene. With a proportion of up to 60% recycled plastic, these nature and universe themed playground equipment are environmentally sustainable.

The Playkit series features themed children's games with cute animals such as funny koalas, elusive snakes, cheerful birds and watchful owls. By playing with the Playkit equipment, children can discover the solar system, get to know the stars, learn the layers of the atmosphere or differentiate the phases of the moon. The Playkit playground equipment has been designed to entertain children safely, being ideal for outdoor playground projects, schools, neighborhood communities and free-access public spaces where budgeting is required.

Jeux pour enfants économiques, robustes, faciles à nettoyer et à désinfecter.

Les jeux d'espaces pour enfants de la série Playkit sont robustes, résistants, faciles à nettoyer et à désinfecter. Une série de jeux pour enfants économiques fabriqués avec des matériaux de première qualité et à haute résistance aux intempéries comme l'acier galvanisé et le polyéthylène de haute densité. Avec une proportion allant jusqu'à 60% de plastique recyclé, ces jeux pour enfants inspirés sur le thème de la nature et de l'univers sont écologiquement durables.

Dans la série Playkit, nous trouvons des jeux à thème pour enfants avec de sympathiques animaux comme les koalas rigolos, les serpents insaisissables, les petits oiseaux joyeux ou les hiboux de garde. En jouant avec les jeux pour enfants Playkit, nous pourrions découvrir le système solaire, connaître les astres, apprendre les couches de l'atmosphère ou différencier les phases de la lune. Les jeux pour enfants Playkit ont été conçus pour divertir les plus petits dans des conditions de sécurité optimales, ils sont idéaux pour les projets de parcs enfantins à l'air libre, les écoles, les maisons de quartier et les espaces publics en libre accès pour lesquels il est nécessaire de s'adapter au budget.



Galería de fotos  
Photo gallery  
Galerie de photos



PARQUES INFANTILES / PLAYGROUND EQUIPMENT / JEUX D'EXTÉRIEUR  
**SERIE PLAYKIT / PLAYKIT SERIES / SÉRIE PLAYKIT**



R4160



R4160M



R4160C



R4162



R4602



R4035



R5017



R4830



R4241



**Columpio Búhos Vigilantes**  
Watchful Owl Swing  
Portique Hibou de Garde

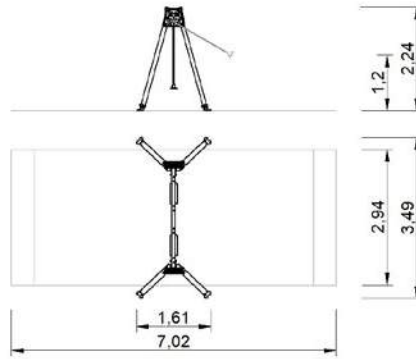

**R4160**



**Columpio Búhos Vigilantes Mixto**  
Mixed Watchful Owl Swing  
Portique Hibou de Garde Mixte

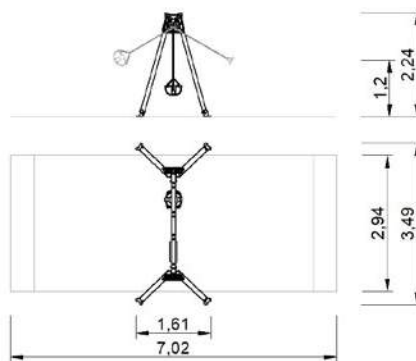

**R4160M**



**Columpio Búhos Vigilantes con Asientos Cuna**  
Watchful Owl Swing with Cradle Seats for Babies  
Portique Hibou de Garde avec Sièges de Sécurité

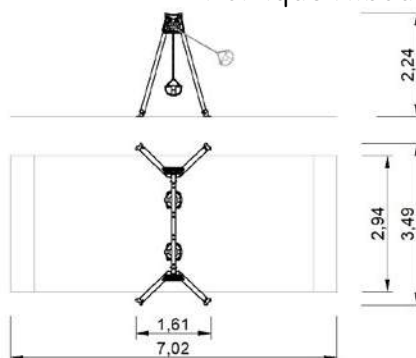

**R4160C**





**Columpio Nido Búhos Vigilantes**  
 Watchful Owl Nest Swing  
 Portique Nid Hibou de Garde

**R4162**

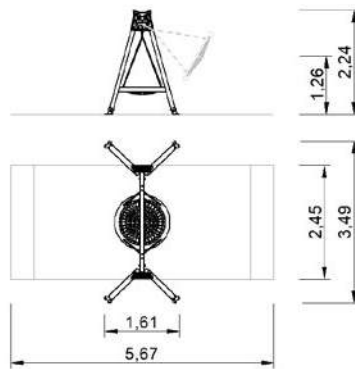

**Balance los Koalas**  
 The Koala Seesaw  
 Balançoire les Koalas

**R4035**

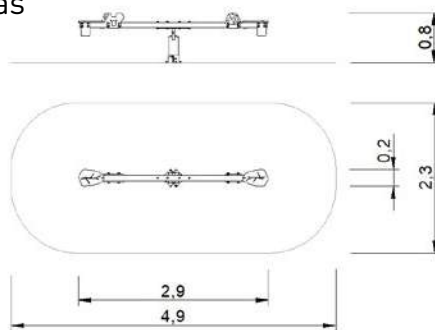

**Muelle Amapola**  
 Poppy Spring Rider  
 Jeu à Ressort le Coquelicot

**R4602**

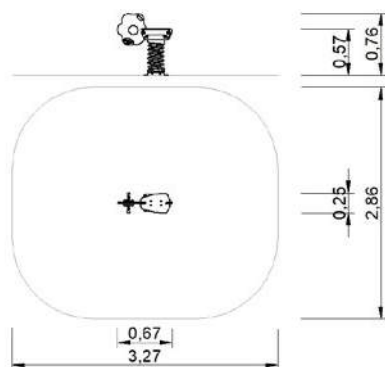





**Tobogán Serpenteante**  
 Serpentine Slide  
 Toboggan Serpentinant

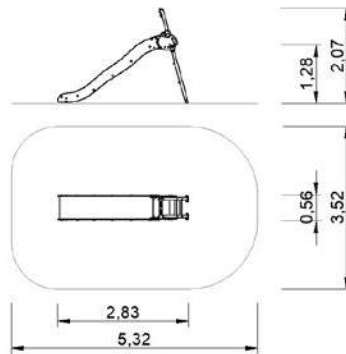

**R4830**



**Casita Planetarium**  
 Planetarium Little House  
 Maisonnette Planetarium

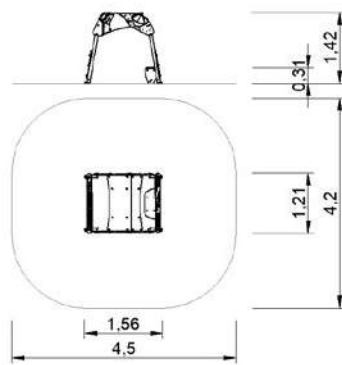

**R5017**



**Multijuego el Árbol**  
 The Tree Playkit  
 Structure Multi-Jeux l'Arbre

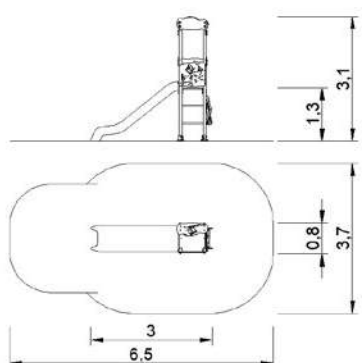

**R4241**



**Juegos de aprendizaje del universo en inglés**

Universe learning english games

Jeux d'apprentissage de l'univers en anglais

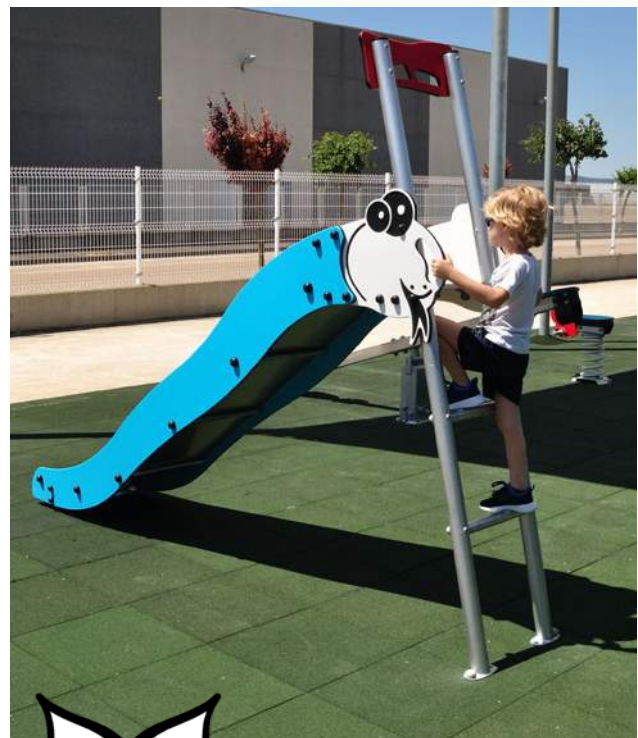
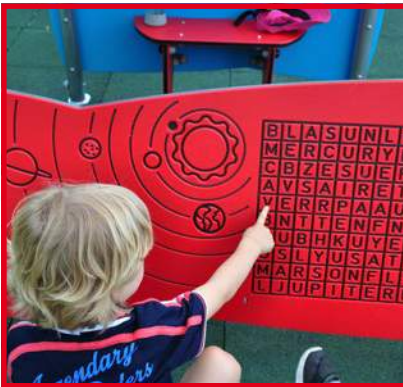
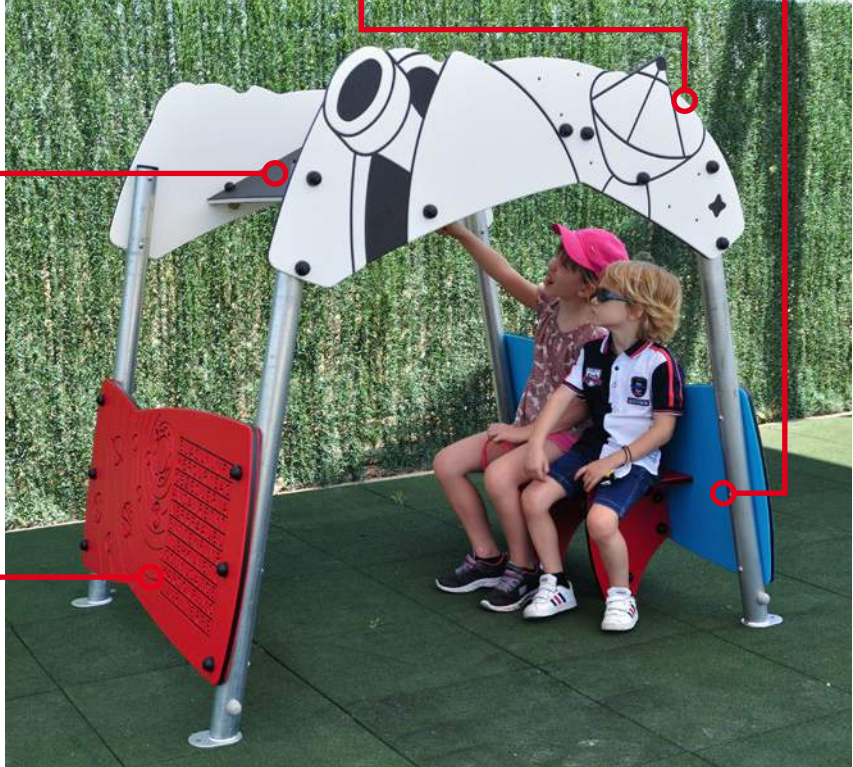







# Circuito de Estimulación Temprana

## Early Stimulation Circuit

### Circuit de Stimulation Précoce

#### CIRCUITO DE ESTIMULACIÓN TEMPRANA:

Es una línea de producto especialmente diseñada y fabricada para los niños más pequeños, concretamente la etapa 0-3 años, aunque pueden utilizarla niños de hasta 6 años.

Fomenta el desarrollo, desde la primera infancia, de destrezas y habilidades fundamentales en el niño, para el juego y aprendizaje en etapas posteriores. Está formada por una serie de juegos desarrollados para estimular y desarrollar las habilidades psicomotrices básicas. No es una adaptación de los juegos para niños mayores a niños pequeños, sino que se parte desde cero para diseñar un juego pensado únicamente en los más pequeños, en las habilidades psicomotrices que han de desarrollar y la estimulación sensorial que necesitan.

El Circuito de Estimulación Temprana potencia la participación del adulto en el juego del niño, mejorando la relación entre ellos, pasando de ser un mero cuidador o espectador a ser parte activa del juego. Involucra a los padres/familiares/cuidadores en el juego diario de los niños

- Trabaja la estimulación sensorial, especialmente la del tacto, la vista y el oído
- Estimula habilidades básicas de motricidad como gatear, andar, braqulear, equilibrio y también la motricidad fina: manipular, agarrar, empuñar
- Trabaja el conocimiento de elementos básicos como: los colores, la luz, las formas, los reflejos, las texturas, el sonido, las horas, el lenguaje básico, los números, el tiempo, idiomas, la naturaleza, animales y plantas, los materiales, etc....
- Para su desarrollo, se ha colaborado con expertos en desarrollo infantil y atención temprana.

#### EARLY STIMULATION CIRCUIT:

This line of products is especially designed and manufactured for younger children, specifically those aged 0-3 years, although they can be used by children of up to 6 years of age.

Promotes the development, from early childhood, of children's basic abilities and skills, for play and later learning in life.

It consists of a series of games designed to stimulate and develop basic psychomotor skills. It is not an adaptation of games made for older children and modified for younger children, rather it has been developed from scratch, creating games specifically for smaller children, the psychomotor skills they need to develop and the sensory stimulation they require.

The Early Stimulation Circuit increases adult participation in children's play, improving the relationship between them, from being a mere minder or spectator to becoming an active part of the game. It involves parents/relatives/caregivers in children's daily play.

- Improves sensory stimulation, especially the senses of touch, sight and hearing
- Stimulates basic motor skills, such as crawling, walking, brachiating, balance and fine motor skills: manipulating, grasping, gripping
- Develops the knowledge of basic elements: colors, light, shapes, reflections, textures, sounds, telling the time, basic language, numbers, the weather, other languages, nature, animals and plants, materials, etc.
- Has been designed in association with experts in child development and early care.

#### CIRCUIT DE STIMULATION PRÉCOCE:

Il s'agit d'une gamme de produits conçus et fabriqués spécialement pour les petits enfants, en particulier agés de 0 à 3 ans mais aussi utilisables jusqu'à 6 ans.

Favorise le développement des connaissances de base et d'habileté chez l'enfant pour le jeu et l'apprentissage dès la petite enfance.

Il se compose d'une série de jeux qui stimule et développe les compétences élémentaires de la psychomotricité. Il ne s'agit pas de jeux pour grands adaptés aux plus petits sinon de jeux spécialement élaborés depuis le début pour les petits.

Le circuit de stimulation précoce favorise la participation de l'adulte au jeu de l'enfant, améliorant leurs relations, le simple surveillant ou spectateur devient ainsi une partie active du jeu. Il implique les parents et toute la famille dans le jeu des enfants.

- Travaille la stimulation sensorielle, en particulier celui du toucher, de la vue et de l'ouïe.
- Stimule la motricité de base tels que la marche, le balancement, l'équilibre et la motricité fine comme manipuler, saisir, toucher.
- Permet la connaissance pratique des éléments de base comme la couleur, la lumière, les formes, les reflets, les textures, les sons, le temps, le langage, les nombres, la nature, les animaux et les plantes, les matériaux, etc....
- Pour développer cette gamme nous avons collaboré avec des experts en développement de l'enfant et d'intervention précoce.



Galería de fotos  
Photo gallery  
Galerie de photos



PARQUES INFANTILES / PLAYGROUND EQUIPMENT / JEUX D'EXTÉRIEUR  
**CIRCUITO ESTIMULACIÓN TEMPRANA**



R5200



R5201



R5203



R5202

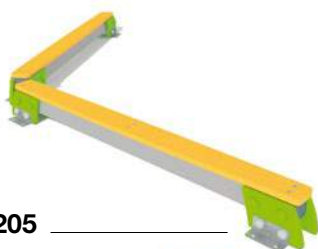

R5205

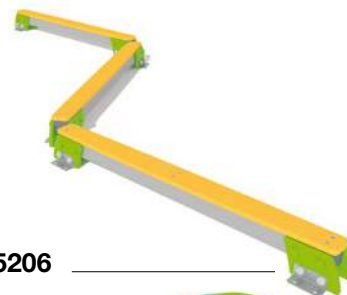

R5206



R5204



R5209



R5210



R5026



R5008



R5100



R5023



R5221



R5222



R5220



**Tunel de gateo de Estimulación Temprana**  
 Crawling tunnel for Early Stimulation  
 Tunnel à ramper pour la Stimulation Précoce

**R5200**

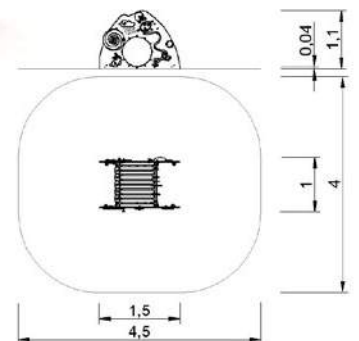

FUNCIONES	JUEGOS	FUNCTIONS	GAMES	FUNCTIONS	JEUX
<ul style="list-style-type: none"> <li>Estimula el gateo y la movilidad del niño.</li> <li>Favorece el desarrollo de las habilidades de escritura, lectura, resolución de problemas y maduración de las diferentes funciones cognitivas</li> <li>Estimula la vista, la psicomotricidad fina y la coordinación corporal</li> <li>Juego del escondite que ayuda en el proceso de separación madre-hijo</li> </ul>	<ul style="list-style-type: none"> <li>Tunel de gateo</li> <li>Espejo esférico</li> <li>Disco girador policromático</li> <li>Disco girador con espiral multicolor</li> <li>Ejercicio "momentos principales del día"</li> <li>Barra con números y letras giratorias</li> <li>Barra con piezas geométricas giratorias y desplazables</li> <li>Mariposa deslizante</li> <li>Juego "El tiempo"</li> <li>Ventanas esféricas de colores</li> </ul>	<ul style="list-style-type: none"> <li>Stimulates crawling and children's mobility</li> <li>Promotes the development of writing, reading and problem solving skills and the maturation of various cognitive functions</li> <li>Stimulates eyesight, fine motor skills and body coordination</li> <li>Playing hide-and-seek assists the mother-child separation process</li> </ul>	<ul style="list-style-type: none"> <li>Crawl Tunnel</li> <li>Spherical mirror</li> <li>Polychromatic spinning disk</li> <li>Spinning disk with multi-colored spiral</li> <li>"Key moments of the day" exercise</li> <li>Bar with rotating numbers and letters</li> <li>Bar with sliding rotating geometric pieces</li> <li>Sliding Butterfly</li> <li>"The time" game</li> <li>Spherical, colored windows</li> </ul>	<ul style="list-style-type: none"> <li>Stimule la marche à quatre pattes et la mobilité de l'enfant.</li> <li>Favorise le développement des aptitudes tel que l'écriture, la lecture, la résolution de problèmes et les différentes fonctions cognitives.</li> <li>Stimule la vue, la psychomotricité fine et la coordination corporelle</li> <li>Jeu de la cachette pour aider au processus de la séparation mère-enfants</li> </ul>	<ul style="list-style-type: none"> <li>Tunnel</li> <li>Miroir sphérique</li> <li>Spirale hypnotique</li> <li>Disque tournant avec des particules multicolore</li> <li>Barre avec des lettres et des numéros mobiles.</li> <li>Barre avec des pièces géométriques tournantes et déplaçables</li> <li>Papillon glissant</li> <li>Jeu du temps</li> <li>Hublot de couleur</li> </ul>



**Braqueador de Estimulación Temprana**  
 Brachiation ladder for Early Stimulation  
 Barre de brachiation pour la Stimulation Précoce

**R5201**

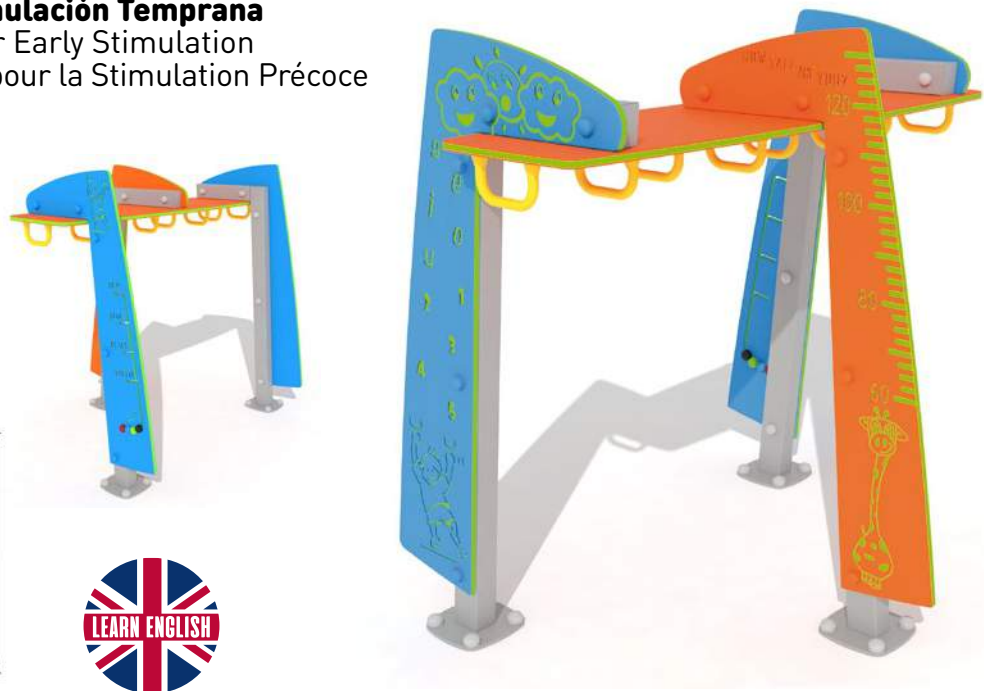
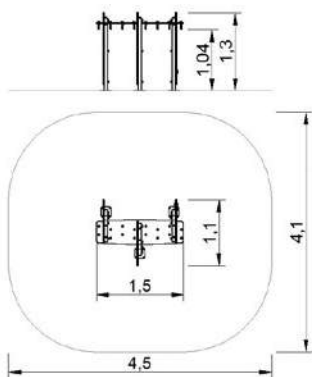

FUNCIONES	JUEGOS	FUNCTIONS	GAMES	FUNCTIONS	JEUX
<ul style="list-style-type: none"> <li>Convergencia oculo-manual</li> <li>Expansión del torax, mejorando la capacidad pulmonar</li> <li>Desarrollo de los músculos del pecho, espalda y hombros</li> <li>Desarrollo de la oposición cortical, esencial para la posterior habilidad de la escritura</li> <li>Aprendizaje bilingüe</li> </ul>	<ul style="list-style-type: none"> <li>Escala de braquiación de 8 asas</li> <li>Medidor de altura "La Girafa"</li> <li>Juego "acierta el color" en inglés</li> <li>Panel con letras grabadas</li> </ul>	<ul style="list-style-type: none"> <li>Hand-eye coordination</li> <li>Expansion of the thorax, improved lung capacity</li> <li>Development of chest, back and shoulder muscles</li> <li>Development of cortical opposition, essential for subsequent writing skill</li> <li>Bilingual Learning</li> </ul>	<ul style="list-style-type: none"> <li>Brachiation ladder with 8 rungs</li> <li>"The Giraffe" height gauge</li> <li>"Guess the color" game in English</li> <li>Panel with engraved letters</li> </ul>	<ul style="list-style-type: none"> <li>Convergence œil-main</li> <li>Expansion du thorax, améliorer la capacité pulmonaire</li> <li>Développement des muscles de la poitrine, du dos et des épaules</li> <li>Développement de l'opposition corticale, essentiel pour l'apprentissage de l'écriture.</li> <li>Apprentissage de l'anglais</li> </ul>	<ul style="list-style-type: none"> <li>Escalier de brachiation de 8 anses</li> <li>Mesure de hauteur "La Girafe"</li> <li>Jeux "trouve la couleur" en anglais</li> <li>Panneau avec des lettres gravées</li> </ul>





**Rampa y escaleras para Estimulación Temprana**  
 Ramp and stairs for Early Stimulation  
 Rampe et escalier pour la Stimulation Précoce

**R5203**

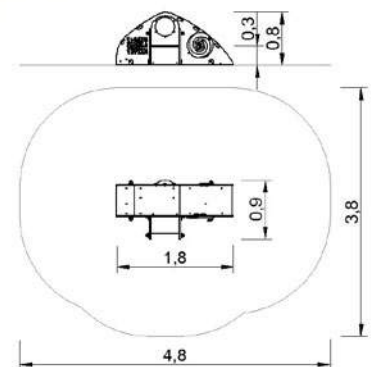

FUNCIONES	JUEGOS	FUNCTIONS	GAMES	FUNCTIONS	JEUX
<ul style="list-style-type: none"> <li>Estimula el gateo y la movilidad del niño.</li> <li>Favorece el desarrollo de las habilidades de escritura, lectura, resolución de problemas y maduración de las diferentes funciones cognitivas</li> <li>Estimula la vista, la psicomotricidad fina, la coordinación corporal y la imaginación</li> <li>Aprendizaje bilingüe</li> </ul>	<ul style="list-style-type: none"> <li>Escalera, rampa inclinada y rampa curva</li> <li>Sopa de letras en inglés</li> <li>Disco girador con espiral multicolor</li> <li>Juego imaginativo astronauta y alien, con claraboyas transparentes</li> <li>Laberinto</li> </ul>	<ul style="list-style-type: none"> <li>Stimulates crawling and children's mobility</li> <li>Promotes the development of writing, reading and problem solving skills and the maturation of various cognitive functions</li> <li>Stimulates eyesight, fine motor skills, body coordination and the imagination</li> <li>Bilingual Learning</li> </ul>	<ul style="list-style-type: none"> <li>Stairs, ramp and curved ramp</li> <li>Word search in English</li> <li>Spinning disk with multi-colored spiral</li> <li>Imaginative astronaut and alien game, with transparent windows</li> <li>Maze</li> </ul>	<ul style="list-style-type: none"> <li>Stimule la marche à quatre pattes et la mobilité de l'enfant.</li> <li>Favorise le développement des aptitudes tel que l'écriture, la lecture, la résolution de problèmes et les différentes fonctions cognitives.</li> <li>Stimule la vue, la psychomotricité fine et la coordination corporelle</li> <li>Apprentissage de l'anglais</li> </ul>	<ul style="list-style-type: none"> <li>Escalier, rampe inclinée arrondie</li> <li>Soupe de lettres en anglais</li> <li>Disque tournant avec spirale multicolore</li> <li>Jeu imaginaire de l'astronoute et d'aliène, avec lucarnes transparentes</li> <li>Labyrinthe</li> </ul>



**Barra de equilibrio de Estimulación Temprana**  
 Balance beam for Early Stimulation  
 Barre d'équilibre pour la Stimulation Précoce

**R5202**

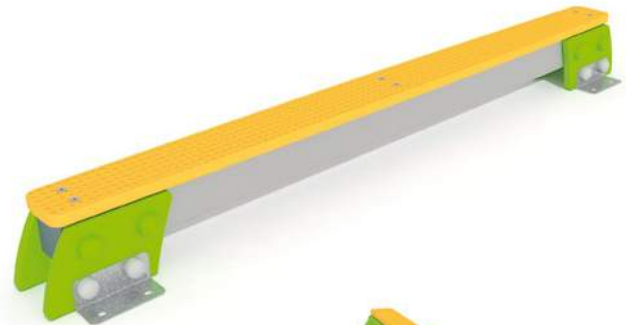
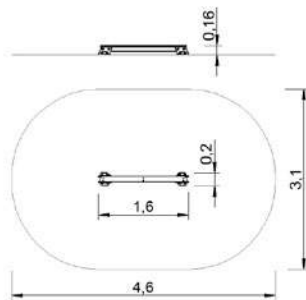

**R5205**

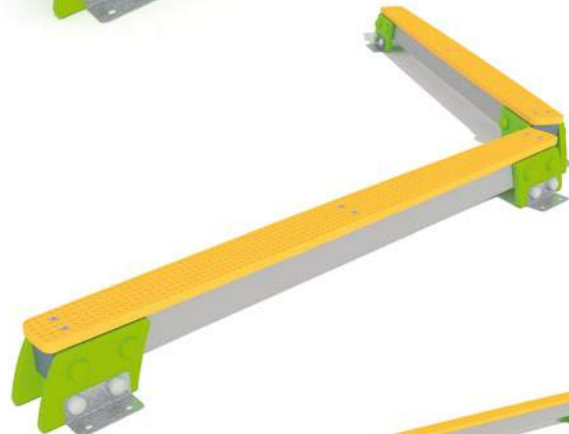
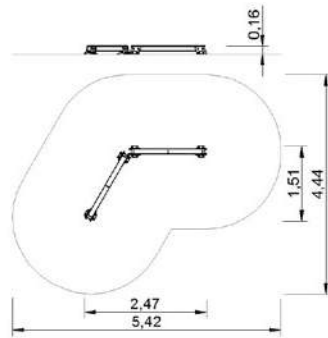

**R5206**

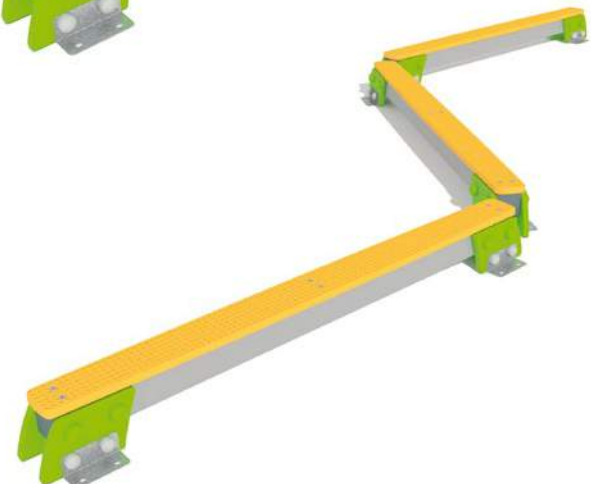
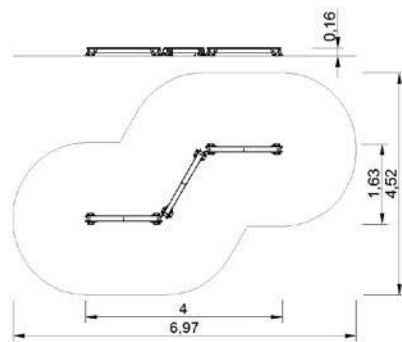

FUNCIONES	JUEGOS	FUNCTIONS	GAMES	FUNCTIONS	JEUX
<ul style="list-style-type: none"> <li>Mejora el equilibrio y la motricidad del tren inferior</li> <li>Aumenta la coordinación óculo-pédica</li> </ul>	<ul style="list-style-type: none"> <li>Ponerse de pie con manos.</li> <li>Caminar en equilibrio.</li> <li>Sentarse y ponerse de pie sin manos.</li> </ul>	<ul style="list-style-type: none"> <li>Improves balance and lower-body motor skills</li> <li>Increases foot-eye coordination</li> </ul>	<ul style="list-style-type: none"> <li>Stand-up using hands.</li> <li>Balance walking.</li> <li>Sit and stand-up without hands.</li> </ul>	<ul style="list-style-type: none"> <li>Améliore l'équilibre et la motricité de la partie inférieure</li> <li>Augmente la coordination œil-pieds</li> </ul>	<ul style="list-style-type: none"> <li>Se lever avec les mains</li> <li>Marcher en équilibre</li> <li>S'asseoir et se lever sans les mains</li> </ul>



## Casita De Estimulación Temprana Early stimulation little house Maisonnette de stimulation précoce

R5023

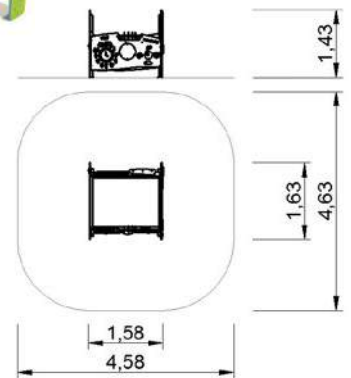

### FUNCIONES

- Aprendizaje mediante el juego de:
  - Geometría, mediante figuras geométricas deslizantes y giratorias.
  - Psicomotricidad fina. Diferentes elementos para la mejora de las habilidades motoras de dedos y manos. Reloj, ábaco deslizante, rueda giratoria, figuras geométricas deslizantes y giratorias.
  - Matemáticas, mediante el ábaco, el reloj, el medidor de altura, la tienda y su ábaco con precios.
  - Lenguajes de integración. Reloj de braille e idioma de signos.
  - Naturaleza, mediante diferentes elementos de juego con figuras de animales y la rueda del clima.
  - Física, mediante el espejo esférico, la claraboya translúcida coloreada y el medidor de altura.

### JUEGOS

- Tienda-ábaco con productos y precios
- Medidor-jirafa
- Reloj braille con lenguaje de signos
- Juego giratorio "el tiempo"
- Juego "adivina el color"
- Claraboya translúcida
- Barra deslizante formas geométricas
- Espejo esférico
- Disco giratorio "abre-cierra"

### FUNCTIONS

- Learning through play:
  - Geometry, through sliding and rotating shapes.
  - Fine psycho motor skills. Different elements that improve the motor skills of the fingers and hands. Clock, sliding abacus, wheel, sliding and rotating geometric figures.
  - Mathematics thanks to the abacus, the clock, the height gauge, the shop and the abacus with prices.
  - Inclusive language. Clock in braille and sign language.
  - Nature, thanks to the different play elements including animals and to the climate wheel.
  - Physical thanks to the spherical mirror, the coloured translucent skylight and the height gauge for children.

### GAMES

- Shop abacus with products and prices
- Giraffe height gauge
- Clock in Braille and Sign Language
- "Weather" rotary play element
- "Guess the color" game
- Translucent skylight
- Slide bar in geometric shapes
- Spherical mirror
- Rotating disc "open-close" element

### FUNCTIONS

- Apprendre par le jeu:
  - La géométrie, à travers les formes en glissement et en rotation.
  - La psychomotricité fine. Différents éléments permettent d'améliorer l'habileté motrices des doigts et des mains. Horloge, boulier coulissant, roue, figures géométriques en glissement et en rotation.
  - Les mathématiques grâce au boulier, à l'horloge, à la toise, la boutique et son boulier avec tarifs.
  - Le langage intégrateur. Horloge en braille et en langue des signes.
  - La nature, grâce aux différents éléments de jeu incluant des animaux et à la roue du climat.
  - La physique grâce au miroir sphérique, à la lucarne translucide en couleurs et à la toise pour enfants

### JEUX

- Boutique-boulier avec produits et tarifs
- Toise en forme de girafe
- Horloge en braille et en langage des signes
- Jeu rotatoire « la météo »
- Jeu « devinez la couleur »
- Lucarne translucide
- Barre-glissière en formes géométriques
- Miroir sphérique
- Disque rotatif « ouverture-fermeture »



### Juego de texturas y formas para Estimulación Temprana

Texture and shape playground for Early Stimulation  
 Jeu de textures et de formes pour la Stimulation Précoce

R5209

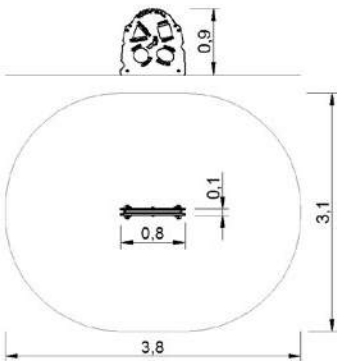
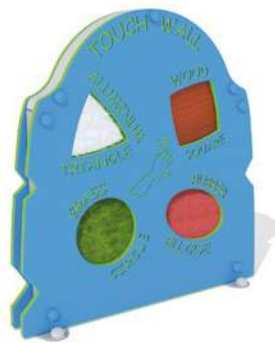

FUNCIONES	JUEGOS	FUNCTIONS	GAMES	FUNCTIONS	JEUX
<ul style="list-style-type: none"> <li>Desarrolla el sentido del tacto</li> <li>Ejercita conocimiento de formas geométricas y materiales</li> <li>Aprendizaje bilingüe</li> </ul>	<ul style="list-style-type: none"> <li>Formado por 8 texturas con 8 formas distintas entre sí</li> <li>Grabados en inglés</li> </ul>	<ul style="list-style-type: none"> <li>Develop the sense of touch</li> <li>Exercises knowledge of geometric shapes and materials</li> <li>Bilingual Learning</li> </ul>	<ul style="list-style-type: none"> <li>Composed of 8 textures in different shapes</li> <li>Engraved in English</li> </ul>	<ul style="list-style-type: none"> <li>Développe le sens du touché</li> <li>Exercice la connaissance des matériaux et de formes géométriques.</li> <li>Apprentissage de l'anglais</li> </ul>	<ul style="list-style-type: none"> <li>Formé par 8 texturas et 8 formes différentes</li> <li>Gravures en anglais</li> </ul>

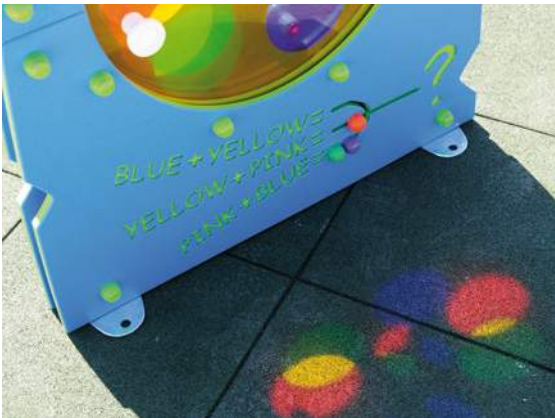

### Juego de luz y color para Estimulación Temprana

Light and color playground for Early Stimulation  
 Jeu de lumière et de couleur pour la Stimulation Précoce

**R5210**

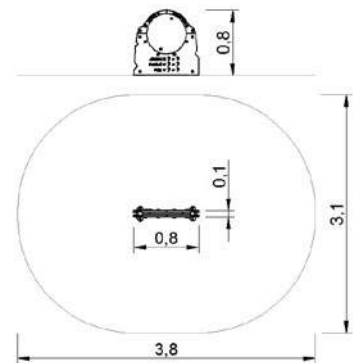

FUNCIONES	JUEGOS	FUNCTIONS	GAMES	FUNCTIONS	JEUX
<ul style="list-style-type: none"> <li>Estimula el sentido de la vista</li> <li>Conocimiento y comprensión de la luz y el color</li> <li>Ejercita la psicomotricidad fina</li> <li>Aprendizaje bilingüe</li> </ul>	<ul style="list-style-type: none"> <li>Juego 'Adivina el color'. Juego mediante fichas deslizantes.</li> <li>Juego '¿Cómo se consigue el color...?'</li> </ul>	<ul style="list-style-type: none"> <li>Stimulates the sense of sight</li> <li>Knowledge and understanding of light and color</li> <li>Exercises fine motor skills</li> <li>Bilingual Learning</li> </ul>	<ul style="list-style-type: none"> <li>"Guess the color" game, with sliding tokens</li> <li>« how do you get the color...? » game</li> </ul>	<ul style="list-style-type: none"> <li>Stimule le sens de la vue</li> <li>Connaissance et compréhension de la lumière et des couleurs</li> <li>Exercice la psychomotricité fine</li> <li>Apprentissage de l'anglais</li> </ul>	<ul style="list-style-type: none"> <li>Jeu "Devine la couleur". avec des fiches glissantes</li> <li>Jeu 'Comment obtient-on la couleur?'</li> </ul>



**Arenero para Estimulación Temprana**  
 Sandbox for Early Stimulation  
 Bac à sable pour la Stimulation Précoce

**R5204**

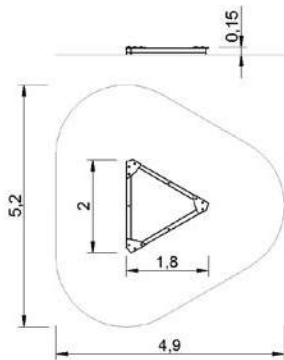

FUNCIONES	JUEGOS
<ul style="list-style-type: none"> <li>· Desarrollo del sentido del tacto, coordinación motora y destreza manual</li> <li>· Con piezas en las esquinas para usar como banquito o mesa</li> </ul>	<ul style="list-style-type: none"> <li>· Conocimiento de materiales diferentes.</li> <li>· Practicar la actividad de moldear.</li> <li>· Juego colaborativo, colectivo.</li> <li>· Trabaja la imaginación.</li> </ul>

FUNCIONES	GAMES
<ul style="list-style-type: none"> <li>· Develops the sense of touch, motor coordination and manual dexterity</li> <li>· With corner pieces to use as stools or tables</li> </ul>	<ul style="list-style-type: none"> <li>· Knowing different materials</li> <li>· Molding practising</li> <li>· Collaborative and collective play</li> <li>· Imagination stimulation</li> </ul>

FUNCIONES	JEUX
<ul style="list-style-type: none"> <li>· Développe le sens du toucher, la coordination motrice et l'habileté manuelle</li> <li>· Avec des pièces sur les côtés pour une utilisation comme banc ou table.</li> </ul>	<ul style="list-style-type: none"> <li>· Connaissance des différents matériaux</li> <li>· Pratiquer l'activité du moulage</li> <li>· Jeu collectif et de collaboration</li> <li>· Travaille l'imagination</li> </ul>

**Mesita-pizarra con banquetas y sillones**  
 Blackboard table with stools and chairs  
 Table-ardoise avec fauteuils et bancs

**R5026**

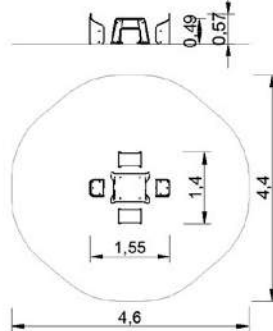

FUNCIONES Y JUEGOS	FUNCTIONS AND GAMES	FONCTIONS ET JEUX
<ul style="list-style-type: none"> <li>· Escritura y dibujo.</li> <li>· Trabaja la imaginación.</li> <li>· Fomenta el juego colectivo.</li> <li>· Inculca el sentido de la limpieza.</li> </ul>	<ul style="list-style-type: none"> <li>· Writing and designing</li> <li>· Imagination stimulation</li> <li>· Collective play</li> <li>· Tidying-up learning</li> </ul>	<ul style="list-style-type: none"> <li>· Écriture et dessin</li> <li>· Travaille l'imagination</li> <li>· Favorise le jeu collectif</li> <li>· Apprend le sens de la propreté</li> </ul>



**La Cosechadora**  
 The Harvester  
 La Moissonneuse-Batteuse

**R5008**

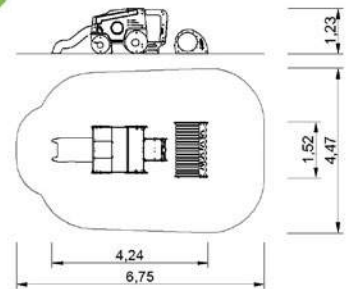

**Laberinto de olas**  
 Wave labyrinth  
 Le labyrinthe à vagues

**R5100**

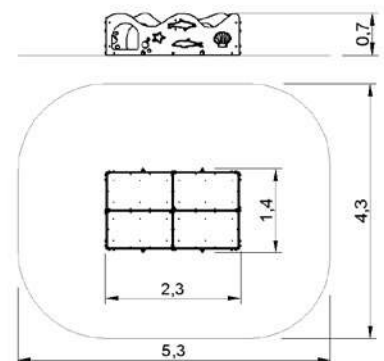



**Túnel SPOOKY Pelusa**  
 SPOOKY Fluffy Tunnel  
 Tunnel SPOOKY Douillet

R5220

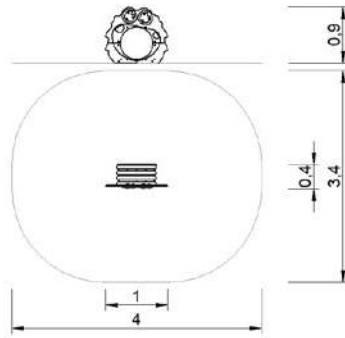

**Túnel SPOOKY Ojitos**  
 SPOOKY Little Eyes Tunnel  
 Tunnel SPOOKY Petits Yeux

R5221

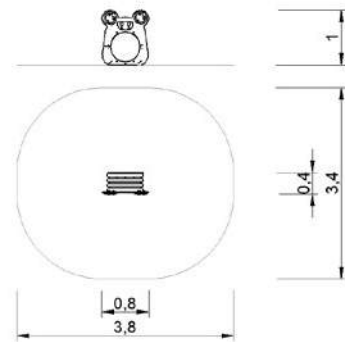

**Túnel SPOOKY Bigotes**  
 SPOOKY Moustache Tunnel  
 Tunnel SPOOKY Moustaches

R5222

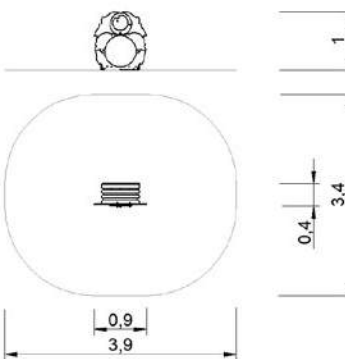









# Serie Integración

## Inclusive playgrounds

## Série d'Intégration

### SERIE INTEGRACIÓN

Los niños y niñas necesitan espacios de juego donde compartir su tiempo sin importar cuáles sean sus capacidades y donde aprendan a vivir en igualdad.

La Serie Integración permite jugar juntos a niños con capacidades diferentes. El objetivo de su diseño no consiste en hacer accesibles los juegos infantiles a niños discapacitados sino a integrar a niños con y sin discapacidad en las áreas de juego y fomentar la diversión en común y las relaciones entre ellos.

Accesibilidad e integración son ambas imprescindibles.

Se trata de una serie de juegos accesibles que fomentan la inclusión de los niños y niñas, padres y madres, abuelos y abuelas, con o sin discapacidad en un mismo espacio de juego. Incorporan paneles de juego y habilidad, elementos sensoriales y musicales y elementos decorativos que estimulan la imaginación.

Las dimensiones y espacios están diseñados para que en caso de ir con acompañantes, estos puedan realizar sus funciones de asistencia de forma cómoda y segura. Fabricados en polietileno de alta densidad, libre de mantenimiento y anti-graffiti, y acero recubierto con pintura termoendurecida y madera de alta calidad de procedencia PEFC certificada, permiten el juego de forma segura.

### INCLUSIVE PLAYGROUNDS

Children need play spaces where they can share time together, no matter what their skills and abilities, and where they can learn to live as equals.

The Integration Series enables children with different abilities to play together. The aim of the design is not to make an accessible playground for children with disabilities, but to integrate children both with and without disabilities in the play areas and encourage them to have fun together and develop relations between them. Accessibility and integration are both essential.

This is a series of accessible games that promote the integration of children, parents, grandparents, either with or without disabilities, in the same play space.

The games incorporate play panels, sensory and musical elements and decorative features that stimulate the imagination.

The dimensions and spaces are designed so that assistants may perform their care duties comfortably and safely.

Made of maintenance-free and anti-graffiti HDPE, thermo-hardened paint coated steel, high quality wood from PEFC certified sources, so children can play safely.

### SÉRIE D'INTÉGRATION

Les enfants ont besoin d'un espace de jeu pour partager leurs temps de récréation, peu importe leurs compétences, permettant de s'adapter à vivre en collectivité et de s'y intégrer harmonieusement sans faire de différence.

L'objectif n'est pas de faire une aire de jeu accessible aux enfants handicapés mais de les intégrer, afin d'encourager les relations entre eux car l'accessibilité et l'intégration sont deux éléments essentiels.

Il s'agit d'une série qui favorise l'intégration des enfants avec ou sans handicap, des parents, grands-parents, dans le même espace de jeu.

Composée de panneaux ludiques, d'éléments sensoriels et musicaux et décoratifs qui stimulent l'imagination.

Les dimensions et les espaces sont conçus de sorte que les accompagnants peuvent surveiller les enfants confortablement et en toute sécurité.

Fabriquée en polyéthylène de haute densité, sans entretien et antigraffiti, en acier recouvert de peinture termoendurecida et en bois de haute qualité, Pin rouge du nord certifié PEFC, traité en autoclave et vernissage à pores ouverts.



Galería de fotos  
Photo gallery  
Galerie de photos



PARQUES INFANTILES / PLAYGROUND EQUIPMENT / JEUX D'EXTÉRIEUR  
 SERIE **INTEGRACIÓN** / **INCLUSIVE** PLAYGROUNDS / SÉRIE **D'INTÉGRATION**



R4112



R4110MCD



R4110MD



R4139MCD



R4139MD



R4141



R4150CD



R4150MD



R4152



R4502



R4505

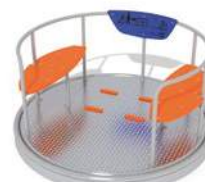

R4507



R4705



R4613



R4614



R4617



R4654



R5200



R5201



R5202

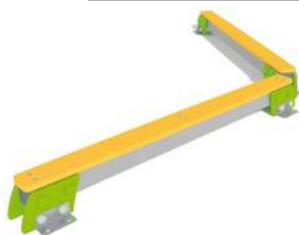

R5205

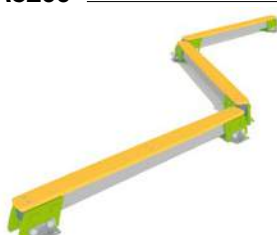

R5205



R5203



R5204



R5209



R5210



R5220



R5221



R5222



R5023

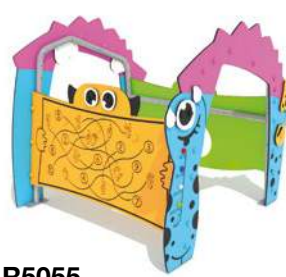

R5055



R5100



R4262DP



R4275

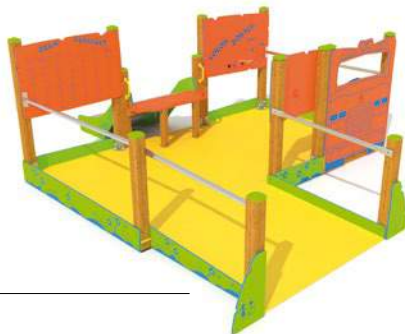

R4279



R4282

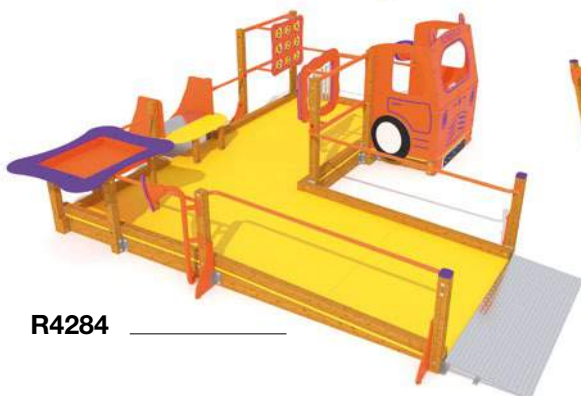

R4284

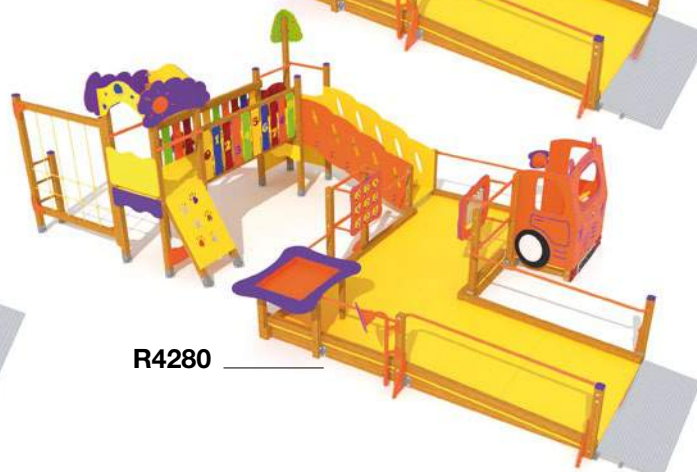

R4280



**Columpio Tribox mixto integración cuna**  
 Inclusive cradle mixed Tribox swing  
 Portique Tribox d'intégration mixte siège bébé

**R4110MCD**

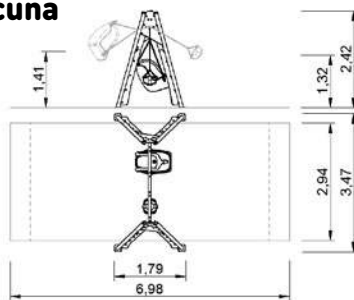

**Columpio Tribox integración mixto**  
 Inclusive mixed Tribox swing  
 Portique Tribox d'intégration mixte

**R4110MD**

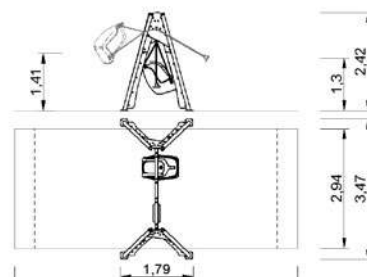

**Columpio nido Tribox**  
 Nest Tribox swing  
 Portique nid Tribox

**R4112**

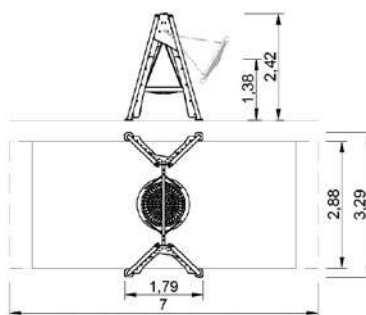

**Columpio Veleta mixto integración cuna**  
 Inclusive cradle mixed Veleta swing  
 Portique Veleta d'intégration mixte siège bébé

**R4139MCD**

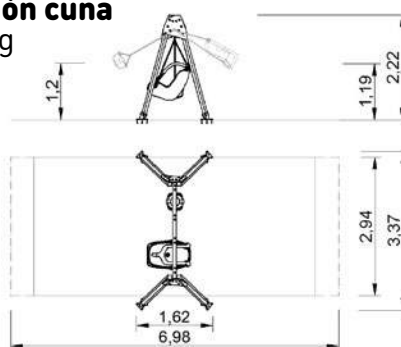

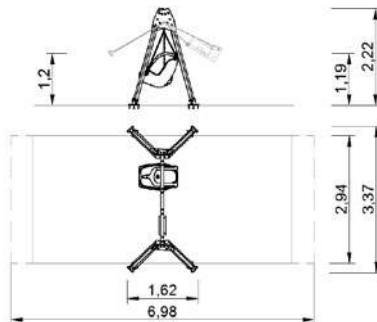

**Columpio Veleta integracion mixto**  
 Inclusive mixed Veleta swing  
 Portique Veleta d'intégration mixte

**R4139MD**

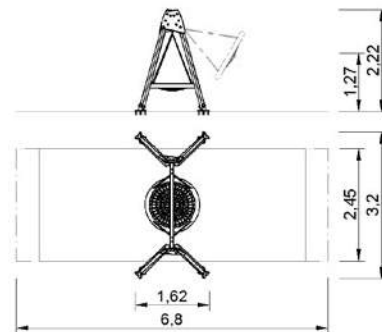

**Columpio Veleta nido**  
 Nest Veleta swing  
 Portique nid Veleta

**R4141**

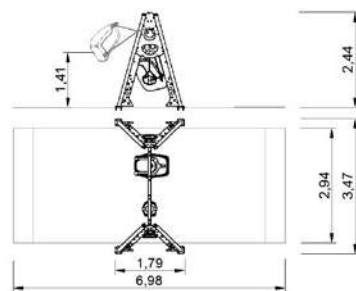

**Columpio SPOOKY Patoso de Integración**  
 Inclusive SPOOKY Clumsy Swing  
 Portique SPOOKY Maladroit d'Intégration

**R4150MCD**

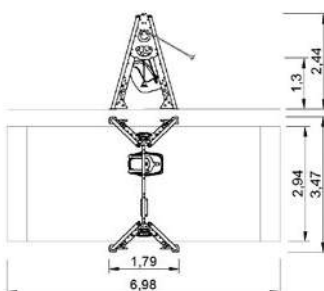

**Columpio SPOOKY Patoso de Integración**  
 Inclusive SPOOKY Clumsy Swing  
 Portique SPOOKY Maladroit d'Intégration

**R4150MD**





**Columpio Nido SPOOKY Pato**  
 Nest SPOOKY Clumsy Swing  
 Portique Nid SPOOKY Maladroit

R4152

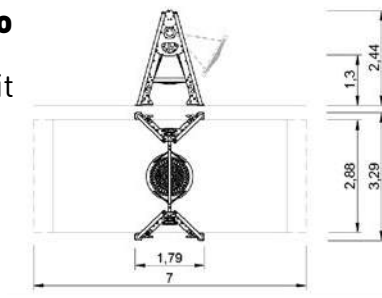

**Carrusel Volador**  
 Flying Carousel  
 Manège Volant

R4502

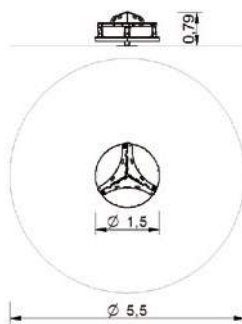

**Carrusel Bowl**  
 Bowl Carousel  
 Manège Bowl

R4505

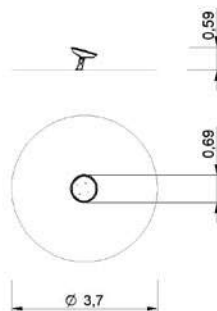

**Carrusel para Todos**  
 Carousel for All  
 Manège pour Tous

R4507

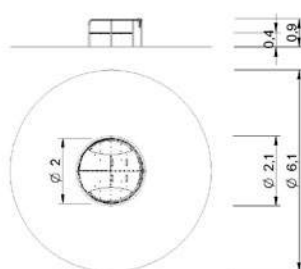



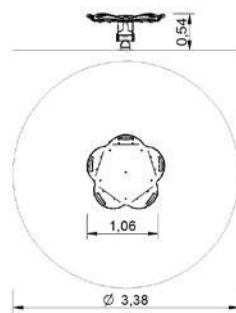

**El Girasol**  
 Sunflower  
 Le Tournesol

R4705

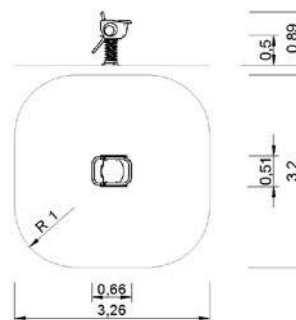

**Muelle de integración**  
 Inclusive spring rider  
 Jeu à ressort d'intégration

R4613

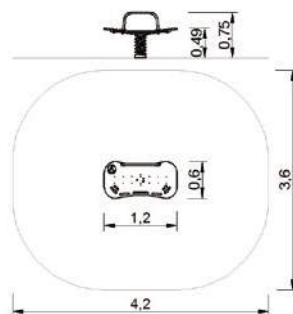

**Tumbona**  
 Snow board  
 Hamac

R4614

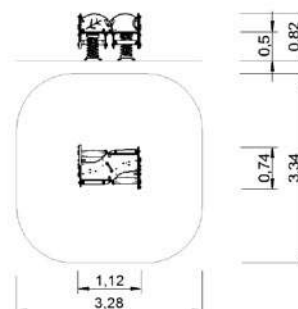

**Muelle Doble Ladybug**  
 Ladybug  
 Ladybug

R4617





**Muelle Integración SPOOKY Pelusa**  
 Handicapped-Ready SPOOKY  
 Fluffy Spring Rider  
 Jeu à Ressort d'Intégration SPOOKY Douillet

**R4654**

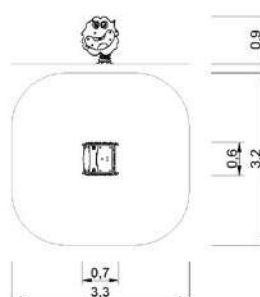

**Tunel de gaseo de Estimulación Temprana**  
 Crawling tunnel for Early Stimulation  
 Tunnel à ramper pour la  
 Stimulation Précoce

**R5200**

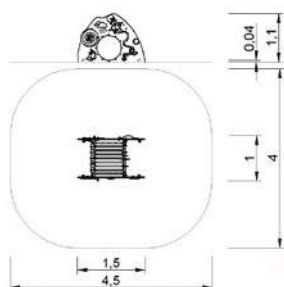

**Braqueador de Estimulación Temprana**  
 Brachiation ladder for Early Stimulation  
 Barre de brachiation pour  
 la Stimulation Précoce

**R5201**

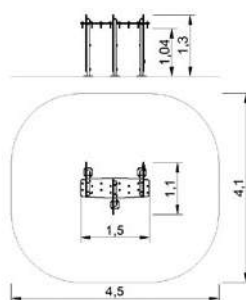

**Rampa y escaleras para Estimulación Temprana**  
 Ramp and stairs for Early Stimulation  
 Rampe et escalier pour la Stimulation Précoce

**R5203**

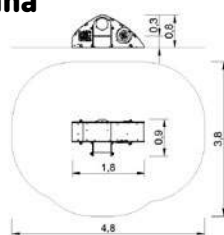

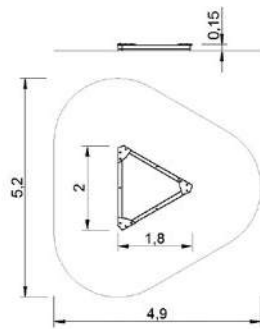

**Arenero para Estimulación Temprana**  
 Sandbox for Early Stimulation  
 Bac à sable pour la Stimulation Précoce

**R5204**

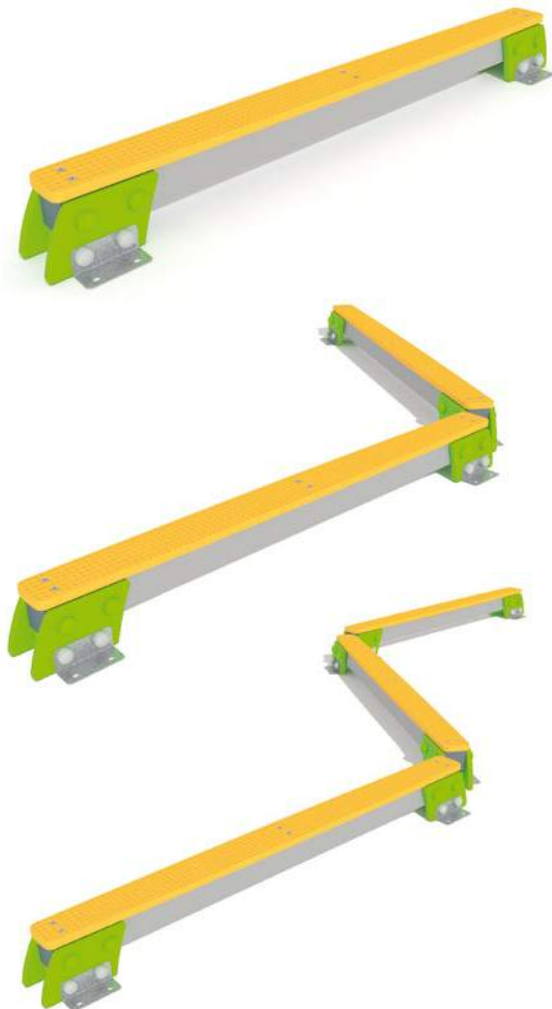

**Barra de equilibrio de Estimulación Temprana**  
 Balance beam for Early Stimulation  
 Barre d'équilibre pour la Stimulation Précoce

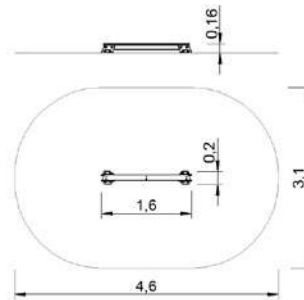

**R5202**

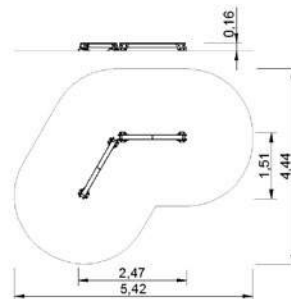

**R5205**

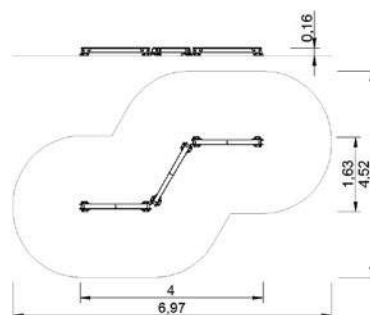

**R5206**





### Juego de texturas y formas para Estimulación Temprana

Texture and shape playground for Early Stimulation  
 Jeu de textures et de formes pour la Stimulation Précoce

R5209

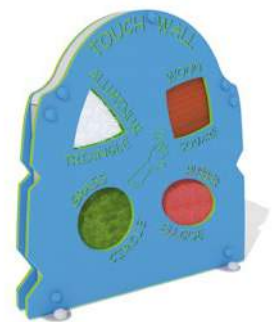
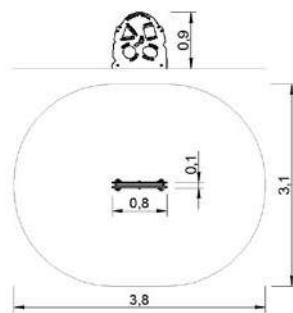

### Juego de luz y color para Estimulación Temprana

Light and color playground for Early Stimulation  
 Jeu de lumière et de couleur pour la Stimulation Précoce

R5210

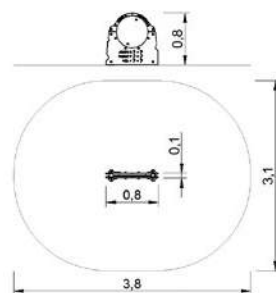

### Túnel SPOOKY Pelusa

SPOOKY Fluffy Tunnel  
 Tunnel SPOOKY Douillet

R5220

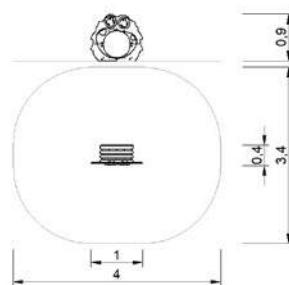

### Túnel SPOOKY Ojitos

SPOOKY Little Eyes Tunnel  
 Tunnel SPOOKY Petits Yeux

R5221

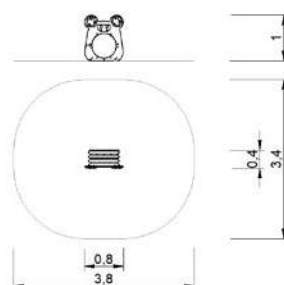

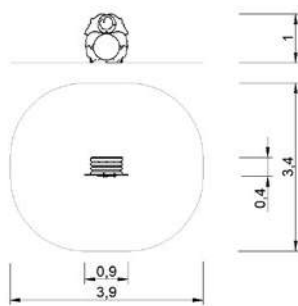

**Túnel SPOOKY Bigotes**  
 SPOOKY Moustache Tunnel  
 Tunnel SPOOKY Moustaches

R5222

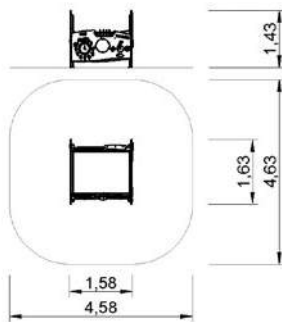

**Casita De Estimulación Temprana**  
 Early stimulation little house  
 Maisonnette de Stimulation Précoce

R5023

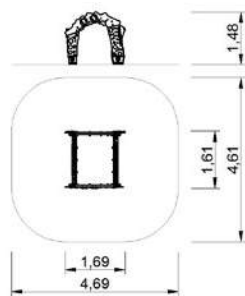
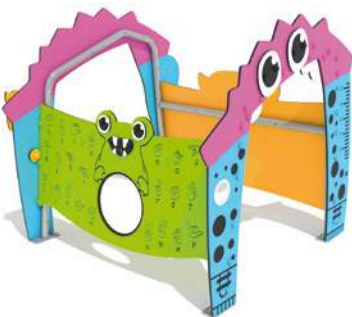

**Casita Integración SPOOKY Pasadizo**  
 Alley SPOOKY House  
 Maisonnette SPOOKY Cachete

R5055

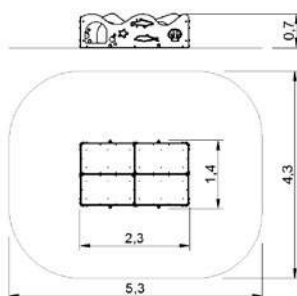

**Laberinto de Olas**  
 Wave Labyrinth  
 Le Labyrinthe à Vagues

R5100





**El galeón para todos**  
 Pirate ship for all  
 Le galion pour tous

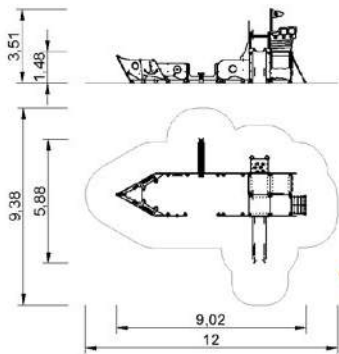

R4262



**Tribox para todos**  
 Tribox for all  
 Tribox pour tous

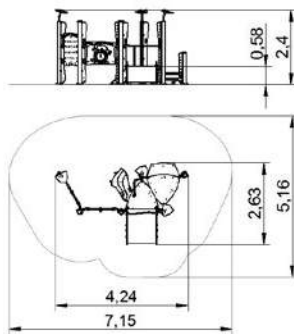

R4275





**Parque de Bomberos Veleta**  
 Fire Station Park Veleta  
 La Caserne de Pompiers Veleta

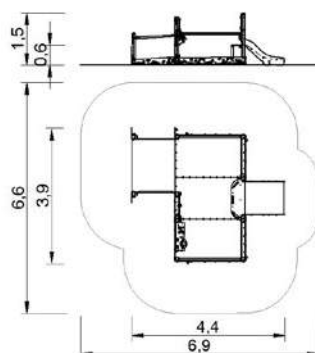

R4279





**Parque de bomberos**  
 Fire station park  
 La caserne des pompiers

**R4280P / R4280X**

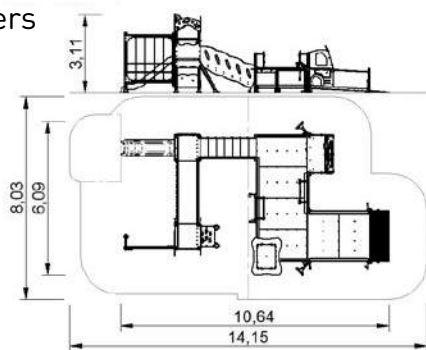

**Parque de bomberos**  
 Fire station park  
 La caserne des pompiers

**R4282P / R4282X**

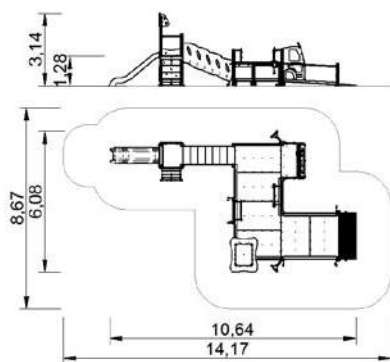

**Parque de bomberos**  
 Fire station park  
 La caserne des pompiers

**R4284**

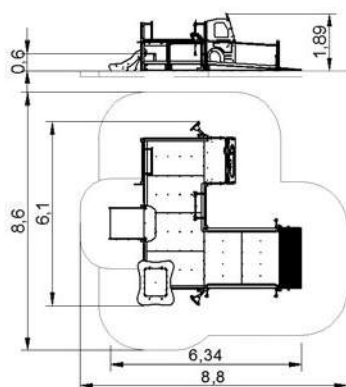









# Juegos Temáticos

## Themed Playgrounds

### Jeux à Thèmes



#### JUEGOS TEMÁTICOS

Nuestra Serie Temática transporta a niños y adultos a un mundo de fantasía, con varias posibilidades temáticas para estimular su imaginación.

Diseños adaptados a la realidad del entorno en los que se fomenta el ocio, el juego y el deporte como parte fundamental de la vida cotidiana y el contacto con el medio ambiente.

Fabricados en polietileno de alta densidad, acero recubierto con pintura termoendurecida y madera de alta calidad, Pino Rojo del Norte con tratamiento en autoclave y con protector láser a poro abierto de procedencia PEFC certificada.

#### THEMED PLAYGROUNDS

Our Thematic Series transports children and adults to a fantasy world, with several possible themes to stimulate their imagination.

The designs are tailored to the particular setting. They encourage leisure, play, sport and contact with the environment as fundamental parts of everyday life.

Manufactured from HDPE, thermo-hardened paint coated steel, high quality wood: PEFC certified, autoclave treated Scots Pine, with open-pore protective wood stain.

#### JEUX À THÈMES

Notre série à thèmes transporte les enfants et les adultes dans un monde de fantaisie, avec plusieurs variantes pour stimuler l'imagination.

Conçue et adaptée afin que le jeu et le sport fassent parti de la vie quotidienne tout en favorisant le contact avec l'environnement.

Fabriquée en polyéthylène de haute densité, en acier recouvert de peinture thermodurcie et en bois de haute qualité, Pin rouge du nord certifié PEFC, traité en autoclave et vernissage à pores ouverts.



Galería de fotos  
Photo gallery  
Galerie de photos



PARQUES INFANTILES / PLAYGROUND EQUIPMENT / JEUX D'EXTÉRIEUR  
JUEGOS **TEMÁTICOS** / THEMED **PLAYGROUNDS** / JEUX À THÈMES



R4260



R4270



R4320



R4262

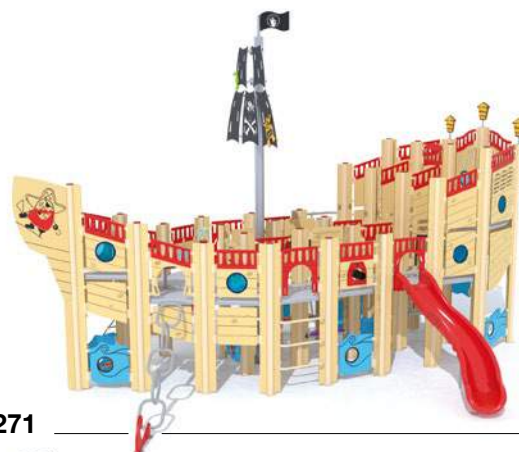

R4271



R4267

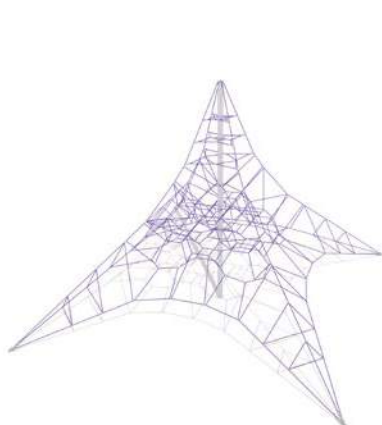

R4972 / R4974

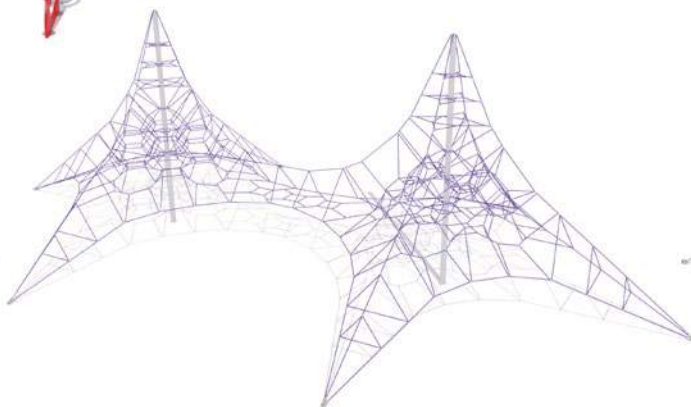

R4973 / R4975

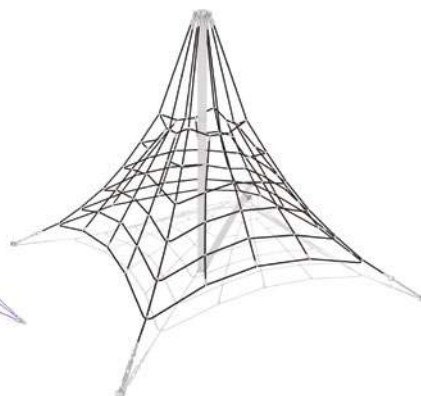

R4977



R4264P



R4265

R4266



R4269



**Monster-truck**  
 Monster-truck  
 Monster-truck

**R4260**

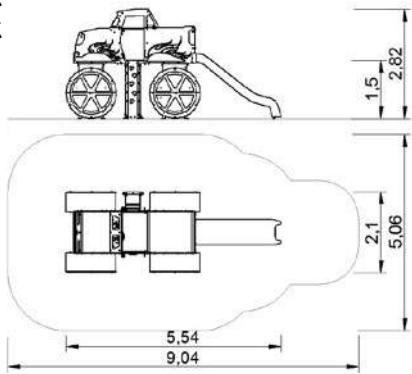

**Ufo**  
 Ufo  
 Ovni

**R4270P**  
**R4270U**  
**R4270X**

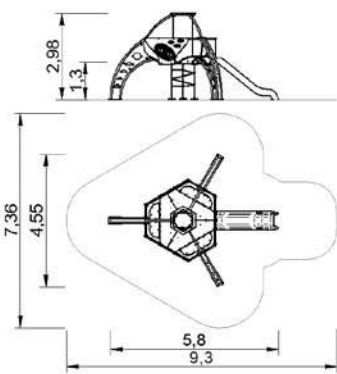

**Tirolina el saltamontes**  
 Sky rider the grasshopper  
 Tyrolienne la sauterelle

**R4320**

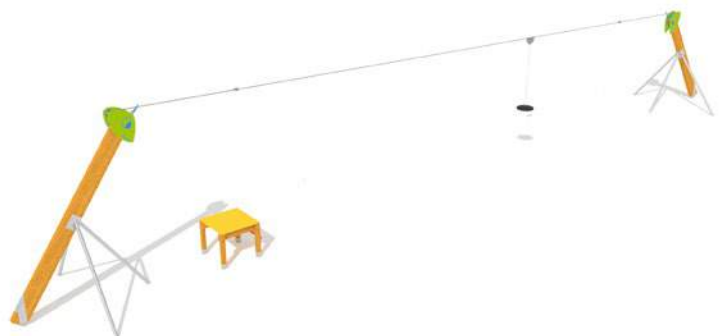
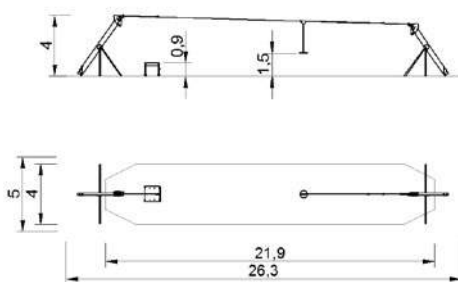

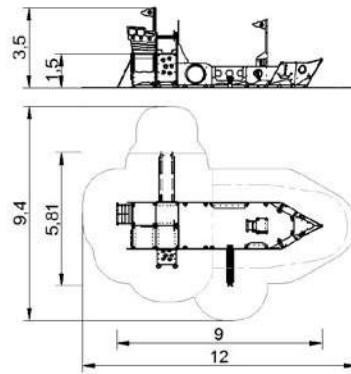

**El galeón**  
 Galeon  
 Le galion

**R4262P**

**R4262DP**

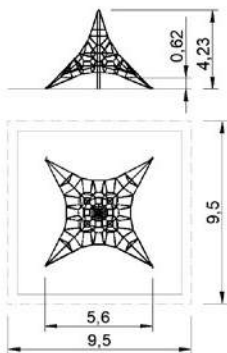

**R4972**

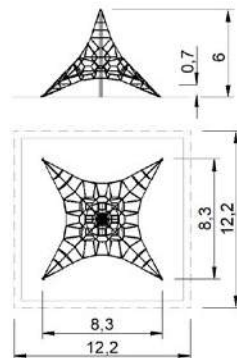

**R4974**

**Piramide tridimensional**  
 Three-dimensional pyramid  
 Pyramide tridimensionnelle

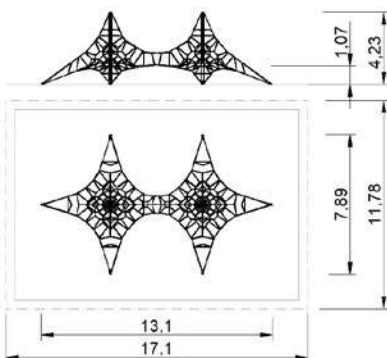
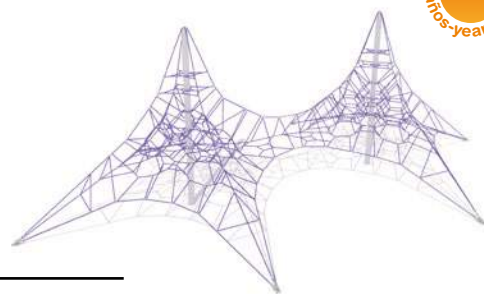

**R4973**

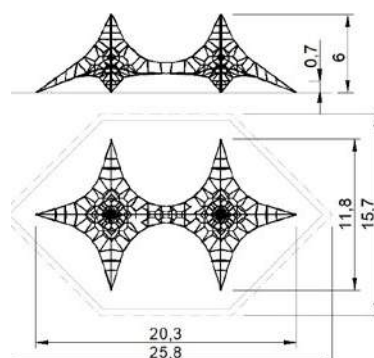

**R4975**

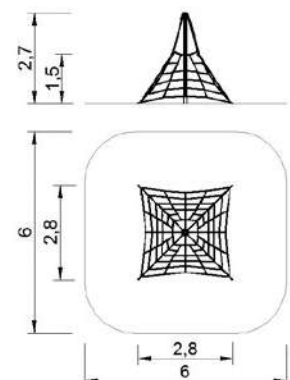

**R4977**



**Carabela Fantasma**  
 Phantom Caravel  
 Caravelle Fantôme

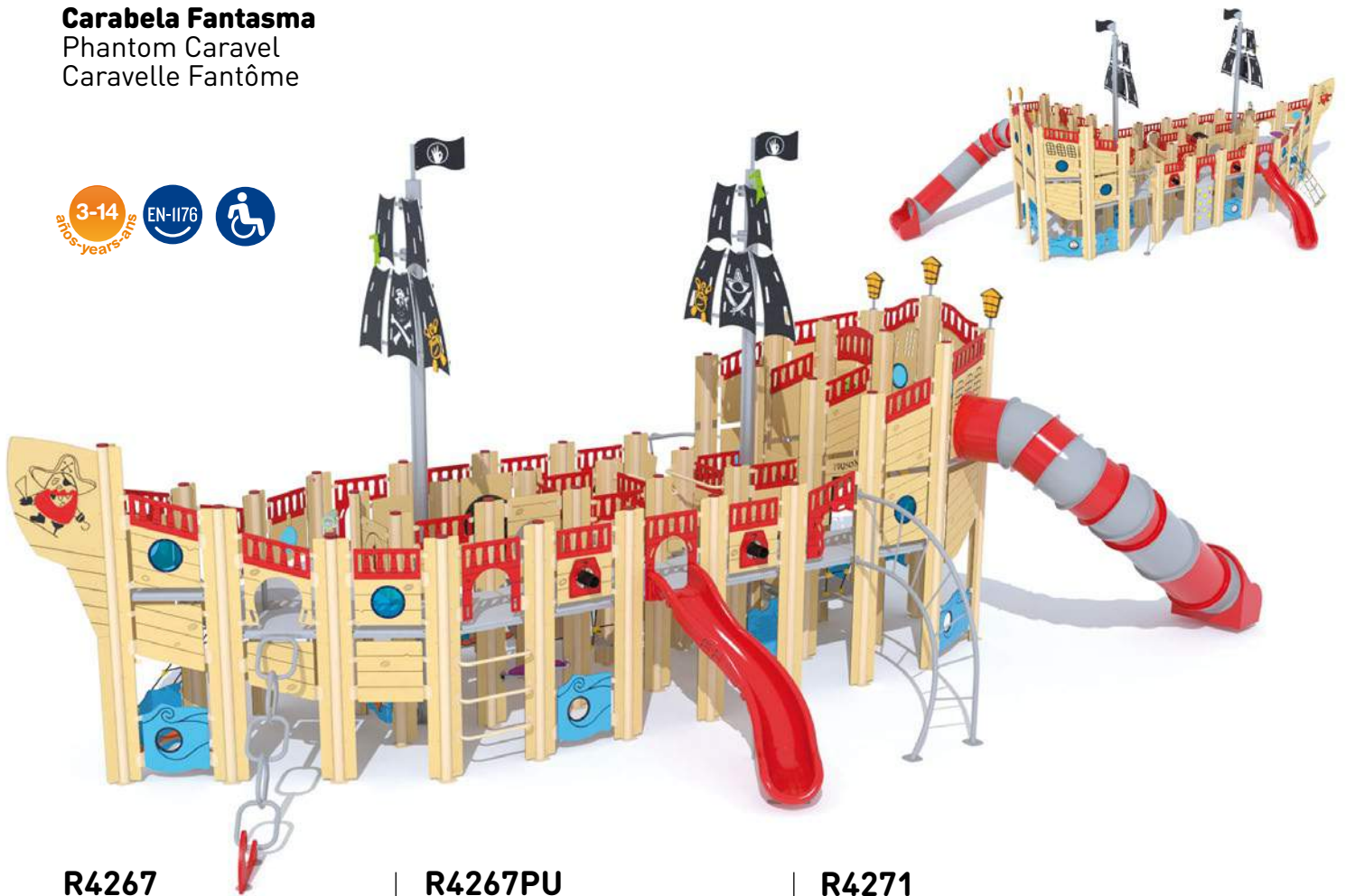

**R4267**

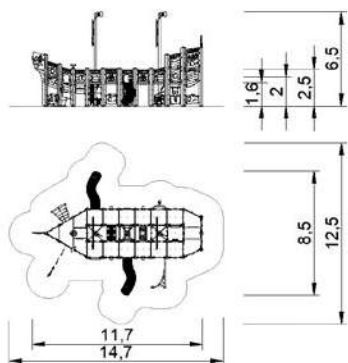

**R4267PU**

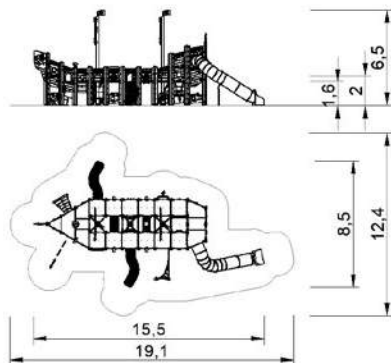

**R4271**

**Carabela "La Niña"**  
 "La Niña" Caravel  
 Caravelle "La Niña"

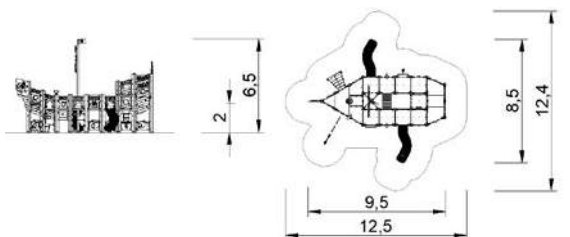





**La Gran Fortaleza**  
 The Great Fortress  
 La Grande Forteresse

**R4264P**  
**R4264X**

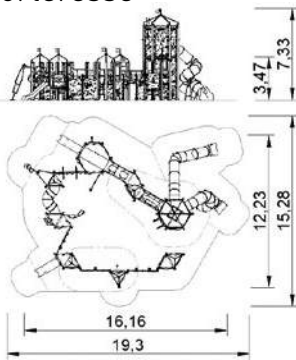

**Fortaleza Torrox**  
 Torrox Fortress  
 Forteresse Torrox

**R4265P**  
**R4265X**

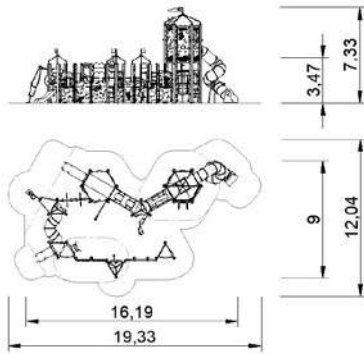

**El Fortín**  
 The Little Fortress  
 La Petite Forteresse

**R4266P**  
**R4266X**

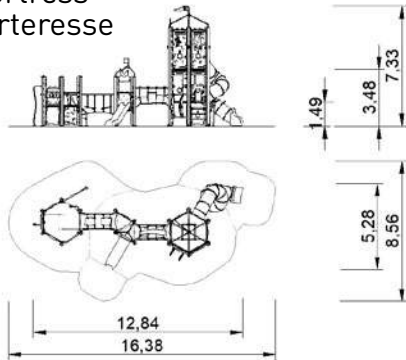

**Fortaleza Doble**  
 Double Fortress  
 Double Forteresse

**R4269P**  
**R4269X**

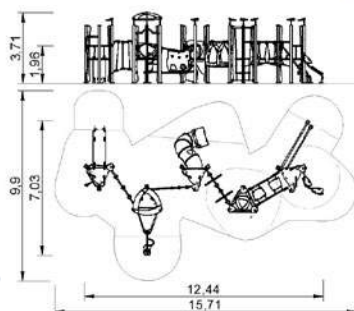







100% Fabricación propia Europea  
100% Own European manufacturing  
100% Propre production européenne



# Complementos

## Accessories

### Compléments

PARQUES INFANTILES / PLAYGROUND EQUIPMENT / JEUX D'EXTÉRIEUR  
**COMPLEMENTOS / ACCESSORIES / COMPLÉMENTS**



R3190



R3532



R3533



R3538



R3539



R4400 / R4405



R4420



R4435

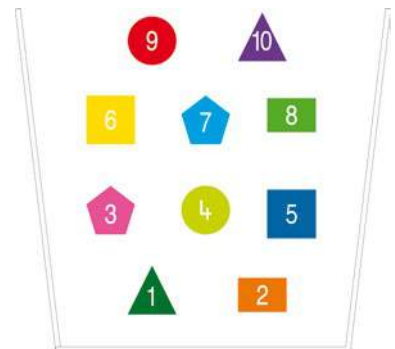

R4440



**Papelera infantil**  
 Playground trash can  
 Corbeille aire de jeux

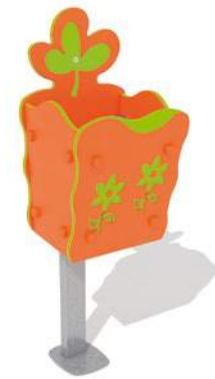
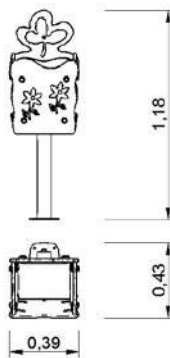

**R3190**

**Valla Veleta**  
 Veleta fence  
 Clôture aire de jeux Veleta

**R3532**

Postes madera tratada y lamas polietileno  
 Treated Wood posts and HDPE slats  
 Poteaux en bois traité et lames en polyéthylène

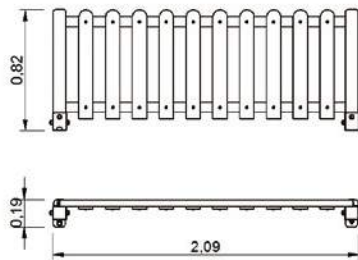

**Postes y lamas de acero**  
 Steel posts and slats  
 Poteaux et lames en acier

**R3533**

Postes y lamas de acero  
 Steel posts and slats  
 Poteaux et lames en acier

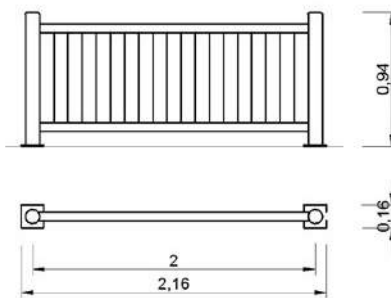

**Valla Tribox**  
 Tribox fence  
 Clôture aire de jeux Tribox

**R3538**

Postes en acero galvanizado y lamas de polietileno  
 Galvanized Steel posts and HDPE slats  
 Poteaux en acier galvanisé et lames en polyéthylène

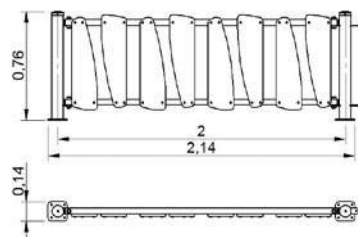

**Valla Juga**  
 Juga fence  
 Clôture aire de jeux Juga

**R3539**

Postes en acero galvanizado y lamas de polietileno  
 Galvanized Steel posts and HDPE slats  
 Poteaux en acier galvanisé et lames en polyéthylène

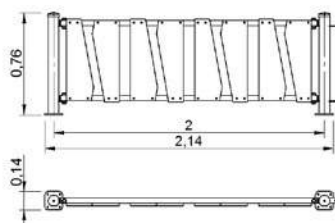

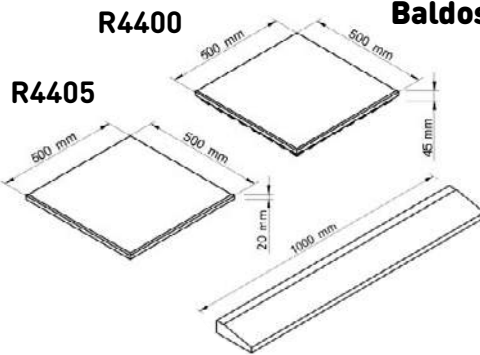

**Baldosa amortiguadora de caucho**

Safety tiles  
 Sol amortissant en dalles

Altura caída  
 Falling height  
 Hauteur de chute:  
 R4400 = 1,40 m  
 R4405 = 0,6 m



**Figuras 3D**  
 Figuras 3D  
 Figuras 3D

R4435

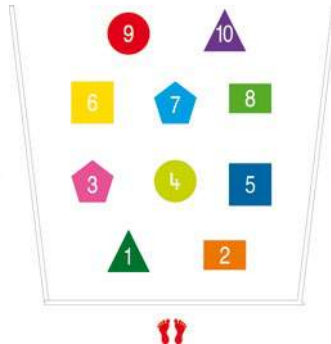

**Juego Pintado para Suelo**  
 Playgrounds Markings  
 Jeux au sol thermocollants

R4440



**Suelo amortiguador continuo EPDM**

EPDM flooring  
 Revêtement de sol en EPDM

R4420











**Plástico Reciclado**  
Recycled Plastic / Plastique Recyclé

 Arcilla / Clay / Argile

 Arena / Sand / Sable

 Grafito / Graphite / Graphite

 Cuarzo / Quartz / Quartz

 Nogal / Walnut / Noyer

 Madera de Pino  
Pine wood  
Bois de pin

 Madera tropical  
Tropical wood  
Bois tropical



# Mobiliario urbano

## Street furniture

### Mobilier urbain



#### SERIE MADERA

La madera utilizada en los bancos proviene de bosques con certificación de gestión forestal sostenible mediante proveedores cuya cadena de custodia está certificada.

Según modelos, madera tropical con certificado FSC, o Pino Rojo del Norte con tratamiento en autoclave certificado a nivel 4, según normativa EN351-2, ambas acabadas con protector láser a poro abierto. Soportes fabricados en acero de alta calidad con distintos acabados y tratamiento.

#### SERIE RECICLADO

El plástico reciclado es la última innovación en materiales para el mobiliario urbano. Su resistencia a la intemperie y al vandalismo es muy superior a la madera, reduciendo el mantenimiento y su coste al mínimo.

Se obtiene a partir de plástico procedente de la recogida selectiva de residuos, fundamentalmente de botellas de leche, mediante procesos de extrusión de plástico para la obtención de listones. Es 100% reciclado y reciclable, formado únicamente por polietileno de alta densidad (HDPE). Es una inversión en un producto respetuoso con el medioambiente, sin duda el mobiliario urbano del futuro.

#### WOOD SERIES

The wood used to make the benches comes from forests certified for sustainable forest management through suppliers whose chain of custody is certified.

Depending on the models, tropical wood with FSC certificate or selected Northern Red Pine (Pinus Sylvestris), V quality, vacuum pressure treated, certified at P4 level according to EN351-2 regulations, and with open pore protector finish. The supports are made of high quality steel with different treatments and finishes.

#### RECYCLED SERIES

Recycled plastic is the latest innovation in materials for street furniture. Its resistance to weather and vandalism is much higher than that of wood, thus reducing maintenance and its cost to a minimum.

Obtained from plastic from selective waste collection, mainly from milk bottles by plastic extrusion processes in order to obtain slats. It is 100 % recycled and recyclable, made up exclusively of high density polyethylene (HDPE). It is an investment in an environmentally friendly product, no doubt the street furniture of the future.

#### SÉRIE BOIS

Le bois utilisé sur les bancs provient de forêts avec certification de gestion forestière durable à travers des fournisseurs dont la chaîne de traçabilité est certifiée.

Selon les modèles, nous utilisons du bois tropical certifié FSC, ou du Pin Rouge du Nord (Pinus Sylvestris) avec traitement en autoclave certifié niveau P4, selon la norme EN351-2, tous les deux avec finition lasure à pores ouverts. Supports fabriqués en acier de haute qualité avec différents traitements et finitions.

#### SÉRIE RECyclÉ

Le plastique recyclé est la dernière innovation en matériaux pour le mobilier urbain. Sa résistance aux intempéries et contre le vandalisme est très supérieure à celle du bois, réduisant l'entretien à un coût minimal.

Il est obtenu à partir de plastique provenant du ramassage sélectif de résidus, principalement de bouteilles de lait, suivant des processus d'extrusion de plastique pour l'obtention de lattes. Il est 100% recyclé et recyclable, composé uniquement de polyéthylène haute densité (HDPE). C'est un investissement dans un produit respectueux de l'environnement, sans aucun doute, le mobilier urbain du futur.



Galería de fotos  
Photo gallery  
Galerie de photos



# MOBILIARIO URBANO STREET FURNITURE / MOBILIER URBAIN



R1069R



R1068SR



R1137SR



R1137R



R1003R



R1400R



R1402R



R2020R



R3048R



R3040R



R3671



R3811



R1068



R1068S



R1137S



R1137



R1120



R1252E



R2031



R2000



R3047



R3085



R3090



R3112



R3119



R3684



R3685



R3605



R3800



R3803



R3804



R3815



R3816



R3953



R3955



R3904



### R1069R®

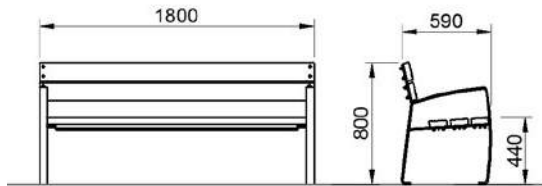

- Arena / Sand / Sable
- Nogal / Walnut / Noyer



### R1068SR®

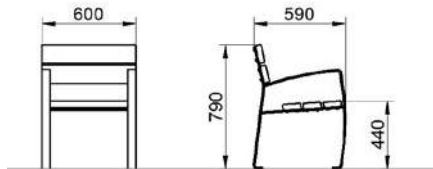

- Arena / Sand / Sable
- Nogal / Walnut / Noyer



### R1137R®

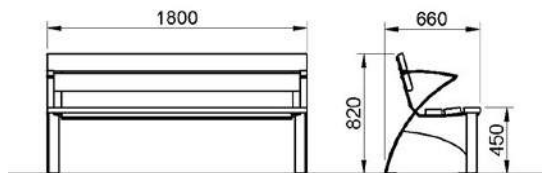

- Arena / Sand / Sable
- Nogal / Walnut / Noyer



### R1137SR®

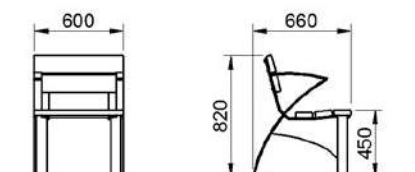

- Arena / Sand / Sable
- Nogal / Walnut / Noyer





### R1003R®

Arena / Sand / Sable

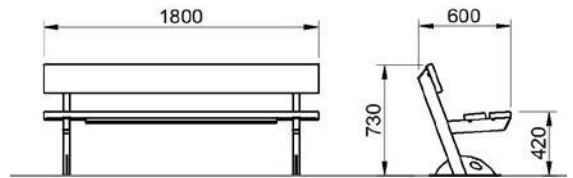

### Tumbona Anaklia R1400R® Anaklia Sunbed Transatlantique Anaklia

Arena / Sand / Sable



Grafito / Graphite / Graphite



Cuarzo / Quartz / Quartz

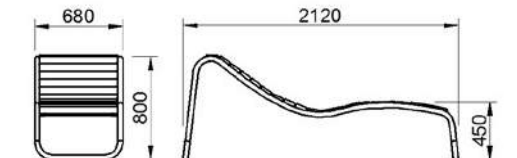

### R1402R®

Grafito / Graphite / Graphite



Cuarzo / Quartz / Quartz

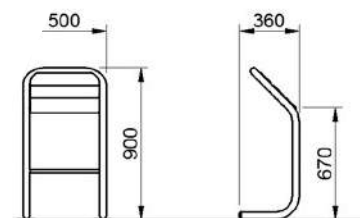

### R3671®

Arcilla / Clay / Argile



Grafito / Graphite / Graphite



Cuarzo / Quartz / Quartz





### R2020R®

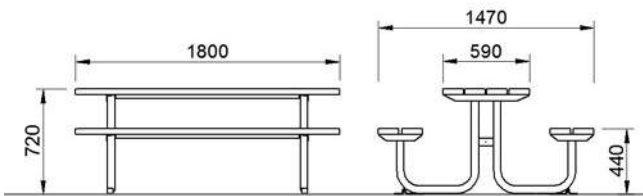



 Arena / Sand / Sable

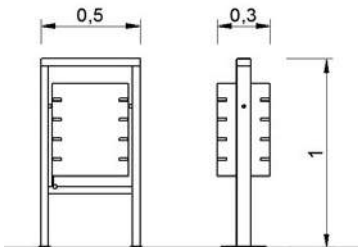

### R3040R®



 Arena / Sand / Sable  
 Nogal / Walnut / Noyer



### R3048R®

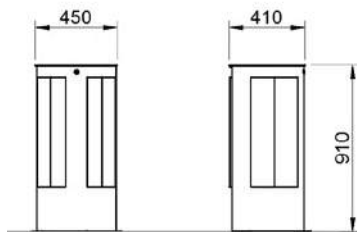

 Arcilla / Clay / Argile  
 Arena / Sand / Sable  
 Grafito / Graphite / Graphite  
 Cuarzo / Quartz / Quartz



### R3811®

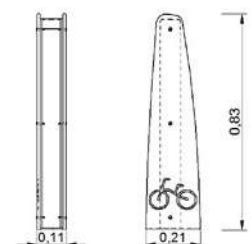

 Grafito / Graphite / Graphite







**R1068S**

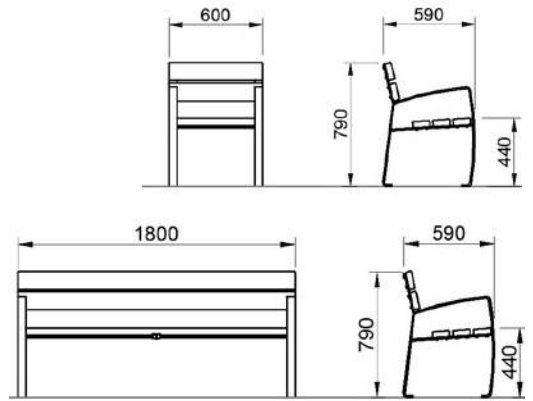

**R1120**

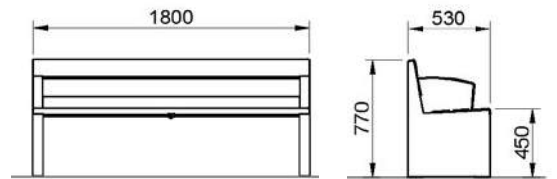

**R1137S**

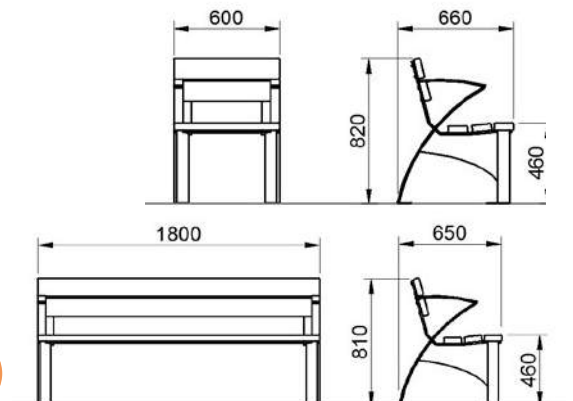



## R2031

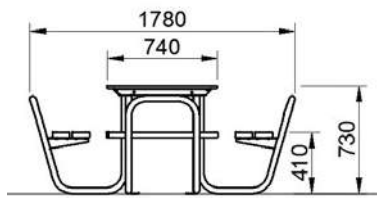

-  Arcilla / Clay / Argile
-  Arena / Sand / Sable
-  Grafito / Graphite / Graphite
-  Cuarzo / Quartz / Quartz



## R1252E

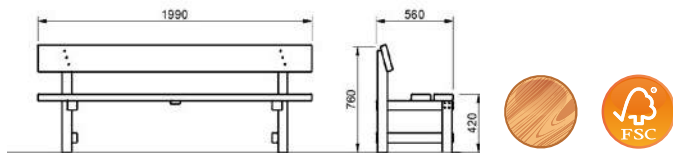

## R2000

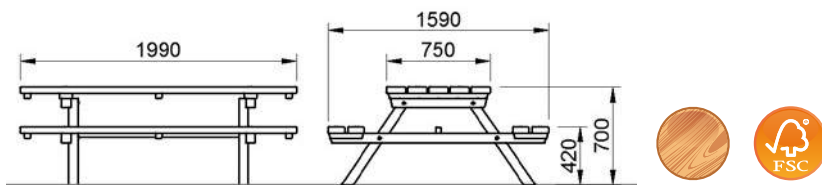

## R3119

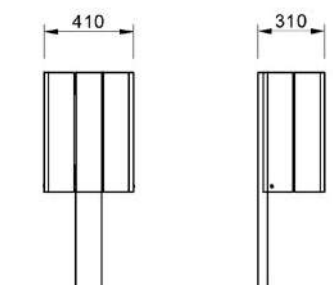

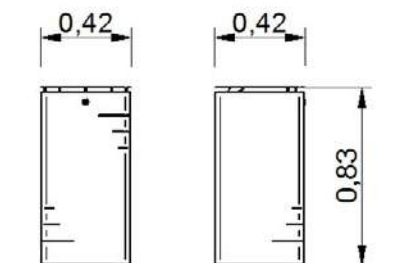

**R3047**

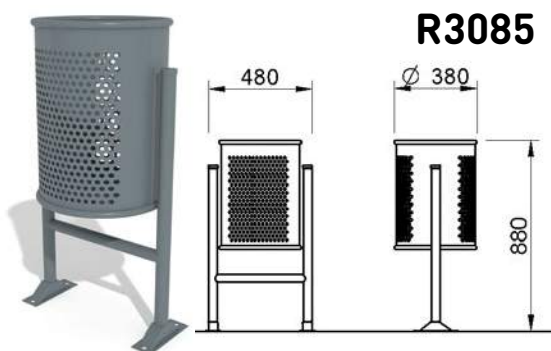

**R3085**

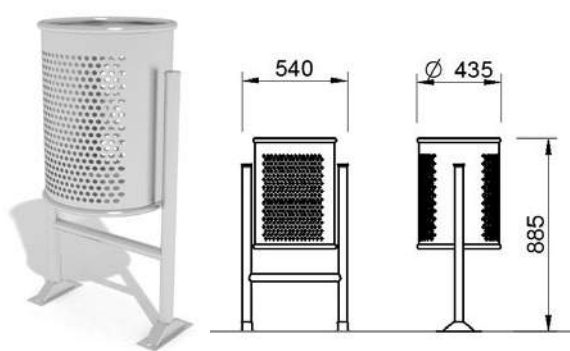

**R3090**

R3087®  
 Cenicero opcional  
 Optional Ashtray  
 Cendrier optionnel

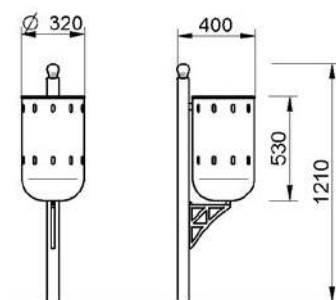

**R3112**



**R3684**

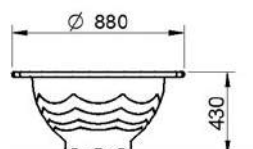

**R3685**

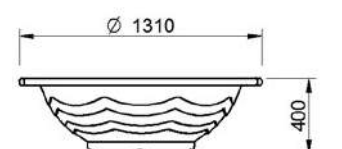



### R3605

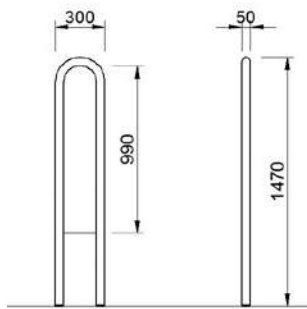

Leyendas diversas  
 Several captions  
 Diverses légendes



### R3800

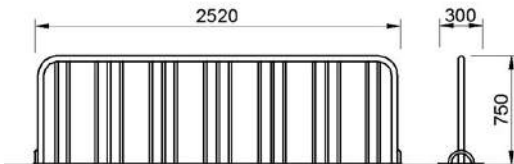

### R3803

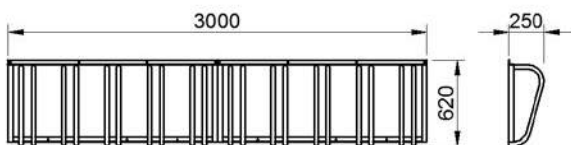

### R3804

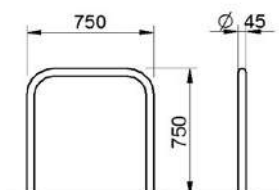

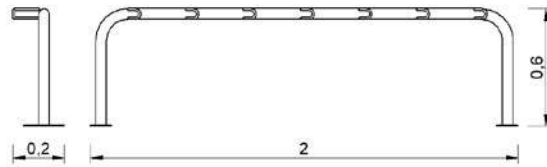

**Aparcapatinetes**  
 Scooter Rack  
 Trotinette Parc

**R3815**

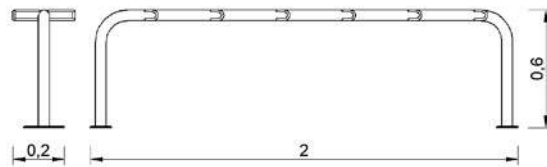
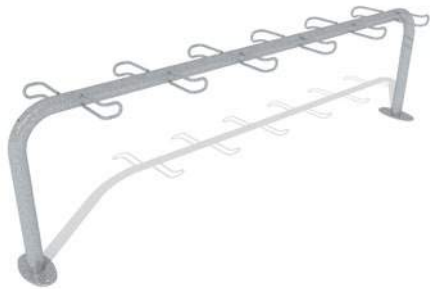

**Aparcapatinetes Doble**  
 Double Scooter Rack  
 Trotinette Parc Doubler

**R3816**

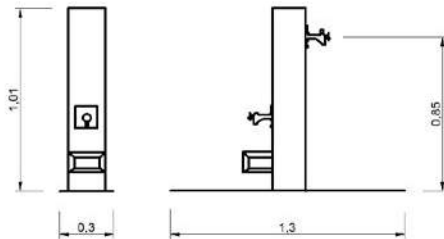

**R3955**

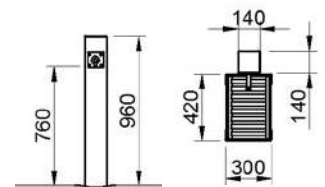

**R3953**

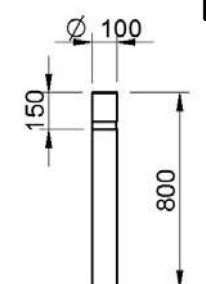

**R3904**

POLIETILENO / POLYETHYLENE / POLYÉTHYLÈNE

 Naranja / Orange / Orange

 Blanco / White / Blanc

PLÁSTICO RECICLADO / RECYCLED PLASTIC / PLASTIQUE RECYCLÉ

 Arena / Sand / Sable

 Grafito / Graphite / Graphite

 Cuarzo / Quartz / Quartz

**SISTEMA MODULAR FLEXIBLE Y ADAPTABLE.**

El mobiliario urbano es considerado como la escala intermedia entre el hombre y la ciudad. La nueva línea DOMO nos permite establecer una relación entre las personas y el entorno urbano, concepto fundamental para el desarrollo de la integridad de un territorio. Se parte de un módulo de 60x80x80 cm que representa la escala del ciudadano. La combinación y acumulación de esta unidad básica o matriz permitirá dar respuesta a las diferentes necesidades y escalas de la nueva ciudad, a la multiplicidad de situaciones que la conforman. Se desarrollan 10 piezas diferentes partiendo de esta unidad básica. 10 elementos que por sus medidas correlacionadas son agrupables permitiendo generar una multiplicidad de combinaciones.

‘Cada lugar es diferente, las necesidades son diferentes, los diseños son diferentes. Un sistema creativo de elección de combinaciones y disposiciones de piezas para cada proyecto...’ Nos encontramos ante un mobiliario ‘sensible’ a su entorno, capaz de mutar de piel según dónde se encuentre. La flexibilidad del sistema le permite adaptarse a las diferentes escalas de la ciudad y el paisaje, garantizando la diversidad dentro de la unidad de un diseño coherente. La línea DOMO se concibe como un sistema flexible; un sistema propositivo abierto a la libre interpretación de los arquitectos, urbanistas y diseñadores del espacio público. De esta forma, cada proyectista puede plantear las combinaciones de elementos y acabados que mejor se adapten a las necesidades de su proyecto.

al galvanizado para obtener un mejor acabado estético del mismo.

Las patas de los elementos del sistema domo están fabricadas con una robusta pletina de 70x12 mm de sección. Como ejemplo, una pata del modelo sillón R01 pesa 20 Kg.

**ACERO INOXIDABLE:** En embellecedores de jardineras y en la tapa de las papeleras, utilizamos acero inoxidable con acabado matizado.

**TORNILLERÍA:** Detalle de la calidad del sistema domo, es la tornillería utilizada para su ensamblaje, de acero inoxidable.

Tornillos tirafondos sujetan las piezas de madera y plástico reciclado.

Toda la tornillería tiene su alojamiento avellanado en las piezas de acero, ocultando las cabezas y eliminando partes salientes.

**ACABADOS:**

**POLIETILENO:** Planchas de polietileno de alta densidad (HDPE) de 2cm de espesor, sin mantenimiento, antigraffiti. Colores muy estables frente a los rayos U.V. y totalmente reciclable. Actualmente es el material con mejores propiedades para usos en el exterior como parques infantiles y mobiliario urbano.

**MADERA:** listones de madera tropical con certificado FSC, acabados con lasur a poro abierto.

**PLÁSTICO RECICLADO:** Piezas en formato tabla o listón obtenidas a partir de plástico procedente de la recogida selectiva de residuos. Estas piezas sustituyen a las tradicionales de madera por su resistencia a la intemperie y al vandalismo. Es 100% reciclado y reciclable, formado únicamente por polietileno de alta densidad (HDPE)



A estos 10 elementos se añaden 5 piezas Accesorio que enriquecen el sistema y resuelven exigencias urbanas no resueltas.

El sistema se basa en una serie de cercos metálicos que recogen diferentes materiales. Según la forma del cerco en sección, obtenemos diferentes elementos; según el material que se le asocie, tendrá diferente aspecto. Cada elemento se desarrolla en 3 materiales diferentes: madera (W), polietileno (P) y plástico reciclado (R).

**MATERIALES**

**ACERO GALVANIZADO:**

El acero utilizado para las principales piezas metálicas del sistema domo está protegido mediante el proceso de galvanizado por inmersión en caliente.

Es uno de los más experimentados y duraderos métodos de protección del acero, que le proporciona a las piezas una capa de zinc antioxidante.

El acero utilizado es granallado previamente

**FLEXIBLE AND ADAPTABLE MODULAR SYSTEM.**

Street furniture is considered as the intermediate level between man and the city. The new DOMO line allows us to establish a relationship between people and the urban environment, which is central to the development of the integrity of a territory.

Starting from a 60x80x80 cm module that represents the scale of citizens. The combination and accumulation of this basic or parent unit will make it possible to meet the different needs and scales of the new city, the multiplicity of situations that make it up. 10 different pieces are developed based on this basic unit. 10 items that, thanks to their correlated measurements, can be grouped to generate a variety of combinations.

5 Accessory pieces are added to these 10 items in order to enrich the system and to



Galería de fotos  
Photo gallery  
Galerie de photos



# Domo Domo Domo

deal with unresolved urban requirements. The system is based on a series of metal frames that hold different materials. Depending on the shape of the frame section, we obtain different elements; depending on the material associated to it, it will have a different appearance. Each element is developed in 3 different materials: wood (W), polyethylene (P) and recycled plastic (R).

'Every place is different, the needs are different, the designs are different. A creative system of choice of combinations and arrangements of elements for each project ...'

We are facing furniture that is 'sensitive' to its environment, able to molt skin depending on where it is located. The system's flexibility allows it to adapt to the different scales of the city and the landscape, while ensuring diversity within the unity of a coherent design.

The DOMO line is conceived as a flexible system, a proactive system open to free interpretation by architects, planners and designers of public space. Thus, each project head can create combinations of elements and finishes that best suit the needs of their project.

#### MATERIALS:

##### GALVANIZED STEEL:

The steel used for the main metal parts of the DOMO system is hot dip galvanized.

It is one of the most experienced and durable steel protection methods, which provides the parts with a layer of antioxidant zinc.

The steel used is blasted prior to galvanization for a better finish.

The legs of the elements of the DOMO system are made of a sturdy sheet 70x12 mm in section. As an example, one leg of the R01 armchair model weighs 20 kg.

**STAINLESS STEEL:** We use stainless steel with a shaded finish for planter trims and litter bin tops.

**FASTENERS:** One detail that shows the quality of the DOMO system are the fasteners used for assembly, made of stainless steel.

Lag screws hold the parts made of wood and recycled plastic.

All fasteners have countersunk heads in steel parts, thus hiding the heads and eliminating protruding parts.

##### FINISHING:

**POLYETHYLENE:** high density polyethylene (HDPE) 2 cm thick, antigraffiti and maintenance free. Colors are very stable against UV rays and fully recyclable. It is currently the material with best properties for outdoor use, such as

playgrounds and street furniture.

**WOOD:** Tropical wood with FSC certificate and open pore protector finish.

**RECYCLED PLASTIC:** Bar or strip from plastic coming from selective waste collection. Its resistance to weather and vandalism is much higher than that of wood, thus reducing maintenance and its cost to a minimum. It is 100% recycled and recyclable, made up exclusively of high density polyethylene (HDPE).

#### SYSTEME MODULAIRE FLEXIBLE ET ADAPTABLE

Le mobilier urbain est considéré comme l'échelle intermédiaire entre l'homme et la ville. La nouvelle ligne DOMO permet d'établir une relation entre les personnes et l'environnement urbain, concept fondamental pour le développement de l'intégrité d'un territoire.

On commence avec un module de 60x60x80 cm qui représente l'échelle du citoyen. La combinaison et l'accumulation de cette unité de base ou souche permettra de répondre aux différents besoins et échelles de la nouvelle ville et à la multiplicité des situations qui la composent.

À partir de ce module de base, on a développé 10 éléments différents. 10 éléments assemblables grâce à leurs mesures correspondantes, ce qui permet de générer une multitude de combinaisons.

À ces 10 éléments, on ajoute 5 pièces Accessoires qui enrichissent le système et dénouent les exigences urbaines non résolues. Le système est basé sur des cadres en métal qui assemblent différents matériaux. Selon la forme de la section du cadre, on obtient différents éléments. Selon le matériau associé, on obtiendra un aspect différent. Chaque élément est décliné en différentes matériaux : bois (W), Polyéthylène (P) et plastique recyclé (R).

« Chaque lieu est différent, les besoins sont différents, les concepts sont différents. Un système créatif de choix de combinaisons et dispositions d'éléments pour chaque projet... » Nous nous trouvons devant un mobilier « sensible » à son environnement, capable de mutations selon le lieu. La flexibilité du système lui permet de s'adapter aux différentes échelles de la ville et du paysage, témoignant de la diversité dans l'unité d'une conception cohérente.

La ligne DOMO se conçoit comme un

système flexible. Un système qui offre une libre interprétation aux architectes, urbanistes et designers de l'espace public. Ainsi, chaque professionnel pourra proposer les combinaisons d'éléments et tons qui s'adaptent le mieux à son projet.

#### MATÉRIAUX:

##### ACIER GALVANISÉ :

L'acier utilisé pour les pièces métalliques principales du système Domo est protégé au moyen d'un processus de galvanisation par immersion à chaud.

C'est l'un des procédés les plus éprouvés et les plus durables de protection de l'acier. Il apporte aux pièces une couche de zinc antioxydant.

L'acier utilisé est grenailé, puis galvanisé, afin d'obtenir une meilleure finition esthétique.

Les pattes des éléments du système Domo sont fabriquées avec une platine robuste de 70x12 mm de section. Par exemple, une patte du modèle « fauteuil R01 » pèse 20 Kg. **ACIER INOXYDABLE:** Sur les enjoliveurs de jardinières ou les couvercles de corbeilles, nous utilisons de l'acier inoxydable avec finition nuancée.

**VISSERIE:** Un détail de la qualité du système Domo est la visserie en acier inoxydable utilisée pour son assemblage. Des vis tirefond maintiennent les pièces en bois et en plastique recyclé.

Dans les pièces en acier on a aménagé des trous lamés pour accueillir la visserie, dissimulant les têtes et éliminant les parties saillantes.

##### FINITION:

**POLYÉTHYLÈNE:** lattes en polyéthylène haute densité (HDPE) de 2 cm d'épaisseur, sans entretien et antigraffiti. Couleurs très stables face aux rayons U.V. et complètement recyclable. Actuellement, c'est le matériau qui présente les meilleures propriétés pour usages extérieurs, comme les aires de jeux et le mobilier urbain.

**BOIS:** Bois tropical avec certificat PEFC et protection lasure à pores ouverts.

**PLASTIQUE RECYCLÉ:** Il consiste en l'obtention de pièces en forme de lattes à partir de plastique provenant de la collecte sélective des déchets. Sa résistance aux intempéries et contre le vandalisme est très supérieure à celle du bois, réduisant l'entretien à un coût minimal. Il est 100% recyclé et recyclable, composé uniquement de polyéthylène haute densité (HDPE).





# MOBILIARIO URBANO STREET FURNITURE / MOBILIER URBAIN



R01P



R02P



R03P



R04P



R05P



R06P



R08P



R09P



R10P



R01R



R02R



R03R



R04R



R05R



R06R



R08R



R09R



R10R



R11R



R01A



R03A



R04A



R05A



R06A

**R01P** Sillón  
Armchair  
Fauteuil

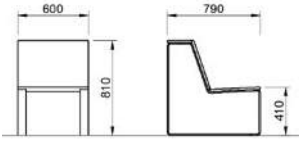

**R02P** Banco  
Bench  
Banc

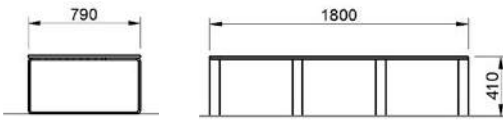

**R03P** Sofá  
Sofa  
Sofa

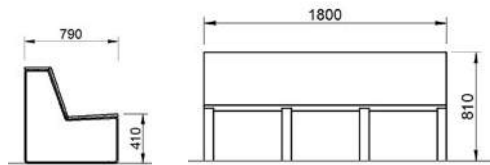

**R04P** Silla  
Chair  
Chaise

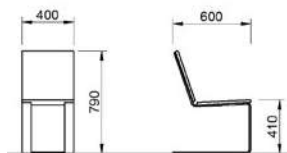

**R05P** Banqueta  
Side table  
Tabouret

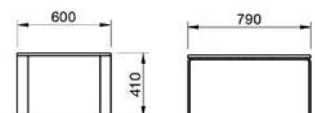



**Mesa**  
Table  
Table **R06P**

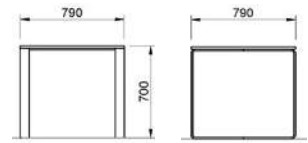

**Yoga**  
Yoga  
Yoga **R08P**

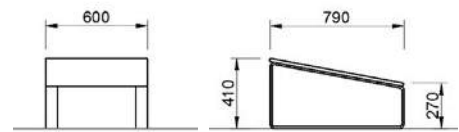

**Papelera**  
Waste basket  
Corbeille **R09P**

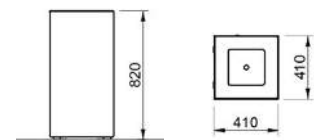



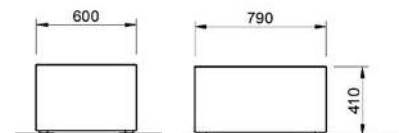

**Jardinera**  
Flowerpot  
Jardinière **R10P**

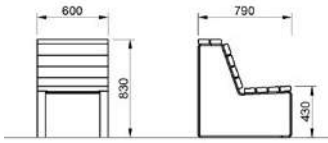

**Sillón**  
Armchair  
Fauteuil

**R01R**







-  Arena / Sand / Sable
-  Grafito / Graphite / Graphite
-  Cuarzo / Quartz / Quartz

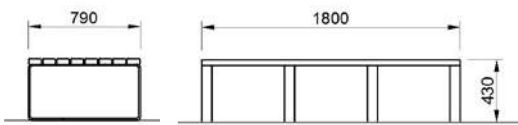

**Banco**  
Bench  
Banc

**R02R**







-  Arena / Sand / Sable
-  Grafito / Graphite / Graphite
-  Cuarzo / Quartz / Quartz

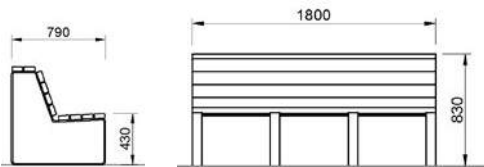

**Sofá**  
Sofa  
Sofa

**R03R**







-  Arena / Sand / Sable
-  Grafito / Graphite / Graphite
-  Cuarzo / Quartz / Quartz

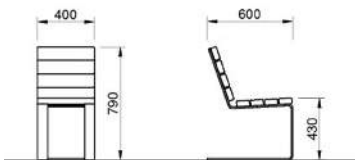

**Silla**  
Chair  
Chaise

**R04R**





-  Arena / Sand / Sable
-  Grafito / Graphite / Graphite
-  Cuarzo / Quartz / Quartz



**Banqueta**  
Side table  
Tabouret

**R05R**





-  Arena / Sand / Sable
-  Grafito / Graphite / Graphite
-  Cuarzo / Quartz / Quartz





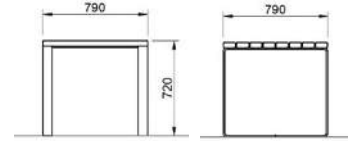

**Mesa**  
 Table  
 Table **R06R**

Arena / Sand / Sable   
 Grafito / Graphite / Graphite   
 Cuarzo / Quartz / Quartz 



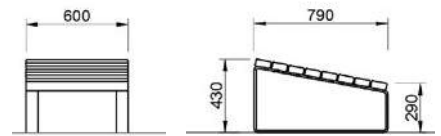

**Yoga**  
 Yoga  
 Yoga **R08R**

Arena / Sand / Sable   
 Grafito / Graphite / Graphite   
 Cuarzo / Quartz / Quartz 



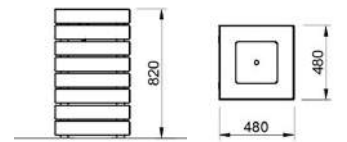

**Papelera**  
 Waste basket  
 Corbeille **R09R**

Arena / Sand / Sable   
 Grafito / Graphite / Graphite   
 Cuarzo / Quartz / Quartz 



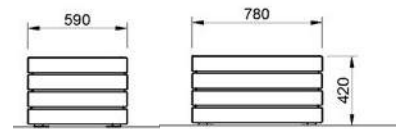

**Jardinera**  
 Flowerpot  
 Jardinière **R10R**

Arena / Sand / Sable   
 Grafito / Graphite / Graphite   
 Cuarzo / Quartz / Quartz 



**Banco orgánico**  
 Organic bench  
 Banc organig **R11R**

Arena / Sand / Sable   
 Grafito / Graphite / Graphite   
 Cuarzo / Quartz / Quartz 

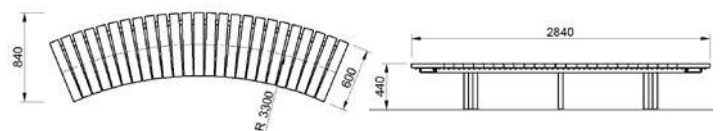

**R01A**  
**Fuente**  
Fountain  
Fontaine

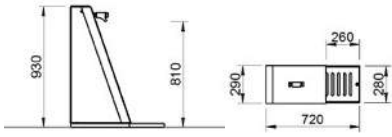

**R03A**  
**Papelera**  
Waste basket  
Corbeille

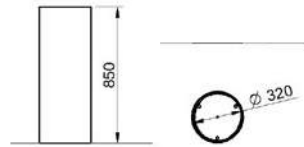

**R04A**  
**Aparcabicis**  
Bicycle rack  
Rang vélo

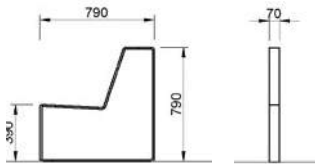

**R05A**  
**Papelera**  
Waste basket  
Corbeille

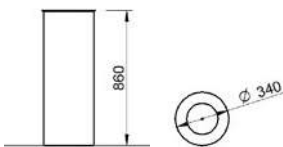

**R06A**  
**Apoyabrazos**  
Armrest  
Accoudoir









# Circuitos deportivos

## Outdoor sport circuits

## Circuits sportifs



El ejercicio físico es uno de los pilares fundamentales de la salud. Según la Organización Mundial de la Salud, la inactividad física es una de las causas principales de las enfermedades no contagiosas a nivel mundial.

Se recomienda la realización de al menos 150 minutos a la semana de ejercicio de intensidad moderada para mantener una buena salud. Desde Industrias Agapito proponemos una variedad de Circuitos Deportivos para todas las edades e intensidad física de la práctica deportiva.

Physical activity is a key factor of good health. According to World Health Organization, physical inactivity is one of the main causes of noncommunicable diseases. 150 minutes per week of moderate-intensity activity is recommended to maintain good health.

150 minutes per week of moderate-intensity activity is recommended to maintain good health. Industrias Agapito offers a variety of Outdoor Sport Circuits for all ages and level of intensity workout.

L'activité physique quotidienne est essentielle à la santé. L'Organisation Mondiale de la Santé estime que l'inactivité physique est l'un des majeurs facteurs de risque, au niveau mondial, favorisant les maladies non transmissibles.

Pour maintenir un bon état de santé, Il est recommandé de pratiquer 150 minutes par semaine d'activité physique modérée. Industrias Agapito propose une offre variée de circuits sportifs en plein air pour tous les âges et tous les niveaux d'intensité d'entraînement.





Galería de fotos  
Photo gallery  
Galerie de photos



VIDEO



# Parques de Calistenia

## Street-Workout Equipment

## Parcs Street Workout



### PARQUES DE CALISTENIA

Calistreetnia es la gama de **Circuitos de Calistenia o Street Workout** de Industrias Agapito. De **fabricación robusta y antivandálica**, están diseñados para su instalación en la vía pública. Todos los aparatos de Calistenia están **certificados bajo la Norma Europea de equipos fijos de entrenamiento físico instalados al aire libre EN16630:2015**.

Los circuitos de Street Workout, que ganan popularidad día a día, ofrecen espacios de entrenamiento físico y mental, fomentando valores positivos y saludables entre los jóvenes deportistas.

Postes fabricados en acero galvanizado en caliente, de diámetro 110 mm y barras en acero galvanizado con pintura de poliéster termoendurecida. Superficies de apoyo y carteles con pictograma explicativo de uso en polietileno de alta densidad. Tornillería en acero inoxidable.

### STREET-WORKOUT EQUIPMENT

Calistreetnia is Agapito Industries' **Calisthenics or Street Workout circuits range**. They are **robust and anti-vandalism manufactured** and designed for their installations in public Parks. All Calisthenics equipment is **certified under the European Standard for permanently installed outdoor fitness equipment EN16630:2015**.

Street workout circuits, which are gaining popularity day by day, offer opportunities for physical and mental training, fostering positive and healthy values among young athletes.

110 mm diameter hot-dip galvanized steel posts, galvanized steel with thermoset polyester finish paint bars. Stepping surfaces and signs with explanatory pictograms in high density polyethylene. Stainless steel bolts and screws.

### PARCS STREET WORKOUT

Calistreetnia est la gamme de **Circuits Calisthénics ou Street Workout** d'Industries Agapito. De **fabrication robuste et anti-vandalisme**, ils sont conçus pour leur installation dans les parcs et jardins publics. Tous les agrès de Calisthénics sont **certifiés par la Norme Européenne sur les modules fixes d'entraînement physique de plein air EN16630:2015**.

Les circuits de Street Workout, dont la popularité croît jour après jour, permettent une formation physique et mentale et promeuvent des valeurs positives et saines chez les jeunes sportifs.

Poteaux de 110 mm de diamètre fabriqués en acier galvanisé à chaud, barres en acier galvanisé recouvert de peinture polyester thermodurcie. Surfaces d'appui et panneaux explicatifs avec pictogrammes en polyéthylène haute densité. Visserie en acier inoxydable.

Con rutinas entrenamiento para distintos niveles  
With street-workout routines for different levels  
Avec des routines d'entraînement pour différents niveaux



**Alta**  
High  
**Haute**  
Intensidad  
Intensity  
Intensité

**+14**  
Años  
Years  
Ans



CIRCUITOS DEPORTIVOS / OUTDOOR SPORT CIRCUITS / CIRCUITS SPORTIFS  
PARQUES DE **CALISTENIA** / **STREET-WORKOUT** EQUIPMENT  
PARCS **STREET WORKOUT**



R7400



R7412



R7414



R7416



R7418



R7420



R7422



R7424



R7426



R7428



R7430



R7432



R7436



R7438



R7440



R7442



R7420D



R7421D



R7474D



R7472



R7473



R7474



R7464



R7466



R7468



R7475



R7476



R7477



R7478



R7479

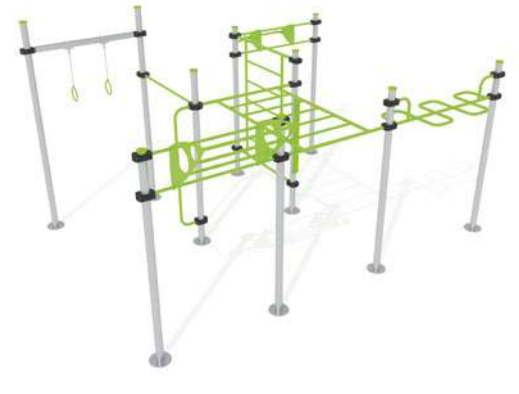

R7480

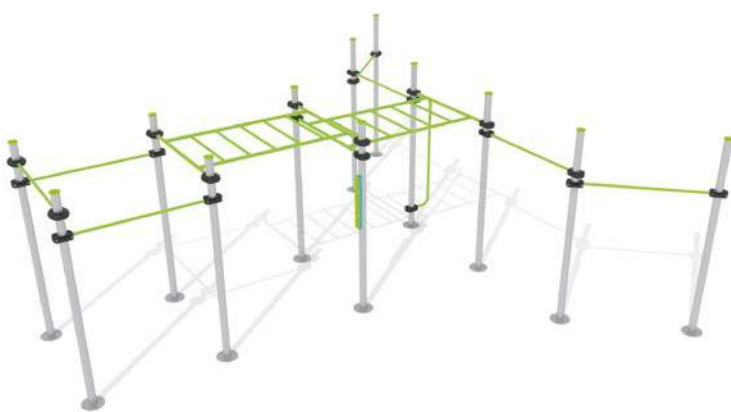

R7481

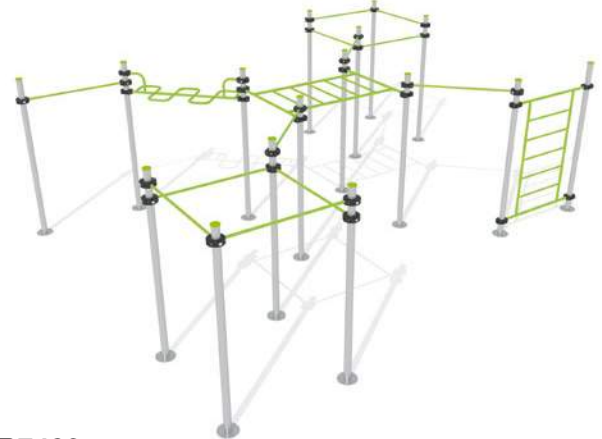

R7483

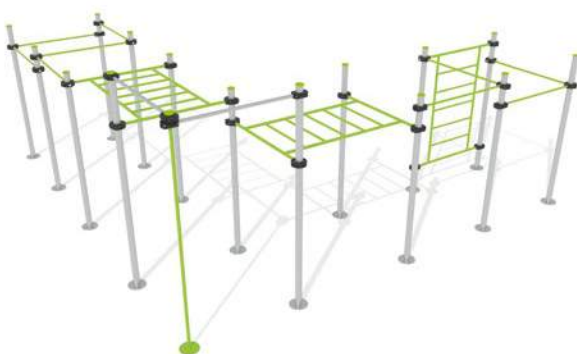

R7485

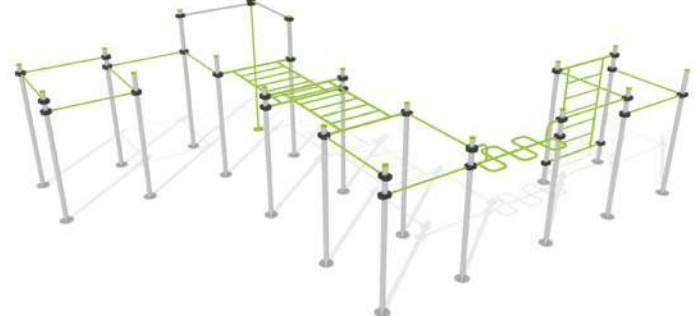

R7487



**Barra vertical**  
 Flag pole. Vertical bar  
 Barre verticale



**Espaldera**  
 Wall bars  
 Espalier



**Barra en voladizo**  
 Corbel bar / projection bar  
 Barre saillante



**Barra de cristos y dominadas**  
 Wide pull ups bar  
 Barre de tractions



**Anillas**  
 Steady rings  
 Anneaux



**Barra de baile**  
 Dancing bar  
 Barre de danse



**Zigzag**  
 Zigzag  
 Zigzag



**Escalador, braquiador ascendente**  
 Ascending brachiation  
 Brachiation ascendante



**Barra paralela h900mm**  
 Parallel bar h900mm  
 Barre parallèle h900mm



**Barra paralela h1200mm**  
 Parallel bar h1200mm  
 Barre parallèle h1200mm



**Flexiones declinadas**  
 Decline pushups  
 Flexions déclinantes



**Conjunto street workout**  
**3 Postes en línea**  
 Street workout set  
 3 Posts en line  
 Ensemble street workout  
 3 Poteaux en ligne



**Barra fija h200-230**  
 Straight bar h200-230  
 Barre fixe h200-230



QR Code

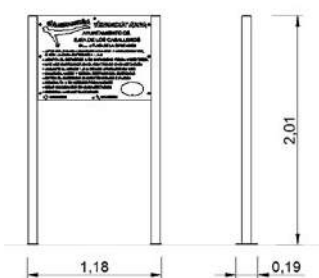

**Cartel general**  
General sign  
Panneau d'information générale

**R7400**

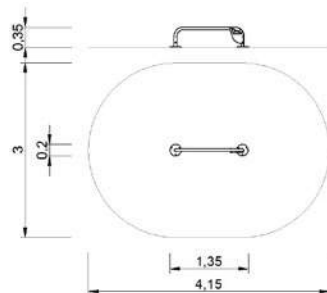

**Barra de flexiones h350mm**  
Push up bar h350mm  
Barre de flexions h350mm

**R7412**

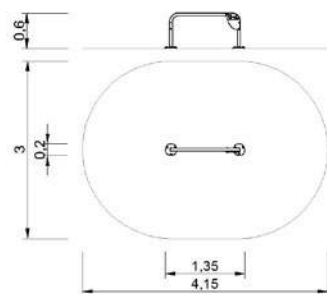

**Barra de flexiones h600mm**  
Push up bar h600mm  
Barre de flexions h600mm

**R7414**

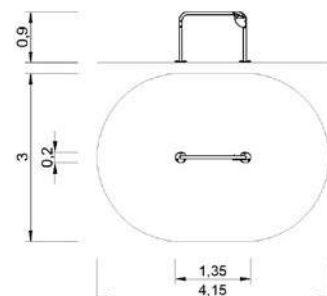

**Barra de flexiones h900mm**  
Push up bar h900mm  
Barre de flexions h900mm

**R7416**





**Barra de flexiones h1200mm**  
 Push up bar h1200mm  
 Barre de flexions h1200mm

**R7418**

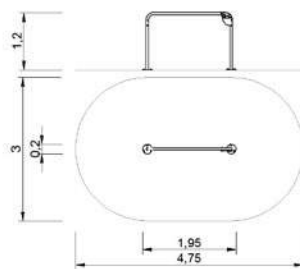

**Barras paralelas h1200mm**  
 Parallel bars h1200mm  
 Barres parallèles h1200mm

**R7420**

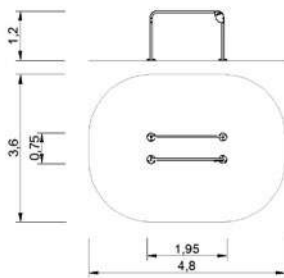

**Barras paralelas triple h1200mm**  
 Triple parallel bars h1200mm  
 Barres parallèles triples h1200mm

**R7422**

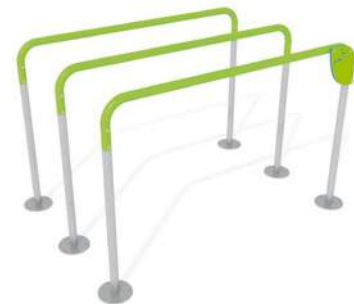
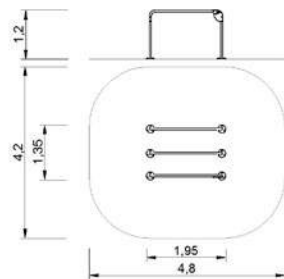

**Barras paralelas h350mm**  
 Parallel bars h350mm  
 Barres parallèles h350mm

**R7424**

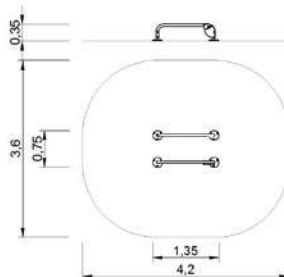



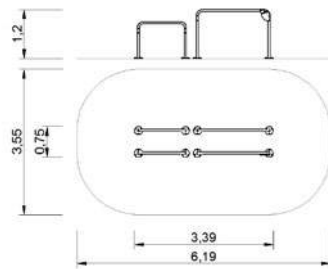

**Barras paralelas 2 a 2**  
2 on 2 parallel bars  
Barres parallèles 2 a 2

**R7426**

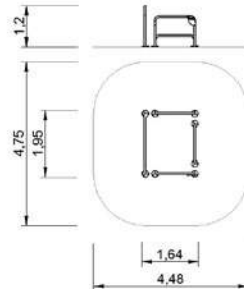

**Cuadrilátero**  
Quadriateral dip  
Quadrilatère

**R7428**

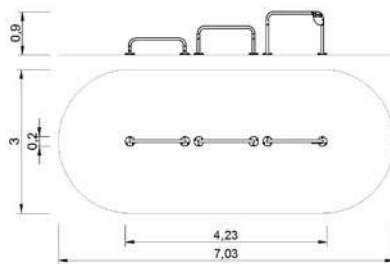
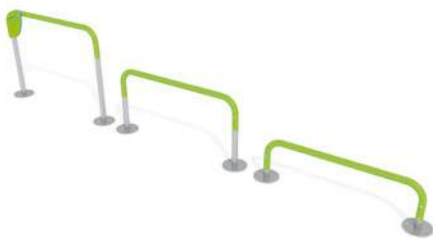

**Triple barra de flexiones h350-600 y 900**  
Triple push up par h350-600 and 900  
Triple barre de flexions h350-600 et 900

**R7430**

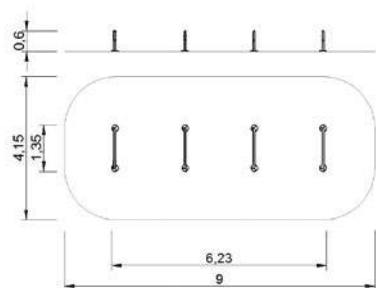

**Valla de salto h600mm, 4 uds.**  
Hurdle h600mm, 4pcs.  
Haie de saut h600mm, 4u.

**R7432**





**Potro doble**  
 Workout desk  
 Double poutre

**R7436**

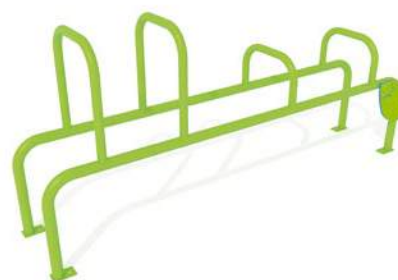
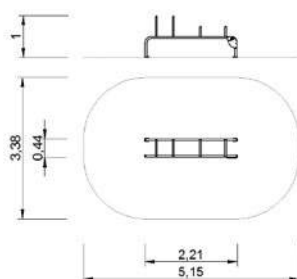

**Punto de equilibrio**  
 Balanced jump point/platform  
 Balanced jump point/platform

**R7438**

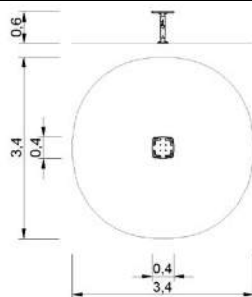

**Juego bastones equilibrista**  
 Handstand pole  
 Piquet d'équilibre

**R7440**

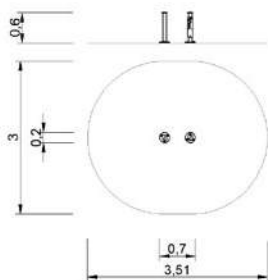

**Abdominales**  
 Abdominal (workout) bench  
 Banc à abdominaux

**R7442**

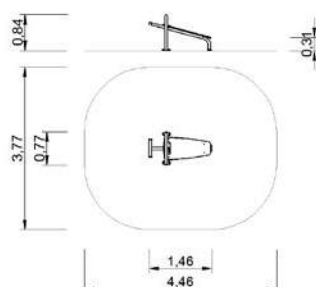

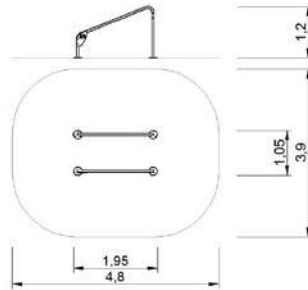

**Barras paralelas  
Inclinadas 600-1200**  
Inclined parallel bars  
H600-1200mm  
Barres parallèles inclinées  
H600-1200mm

**R7420D**

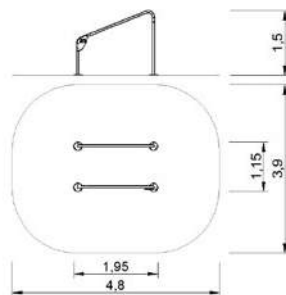

**Barras paralelas  
Inclinadas 900-1500**  
Inclined parallel bars  
H900-1500mm  
Barres parallèles inclinées  
H900-1500mm

**R7421D**

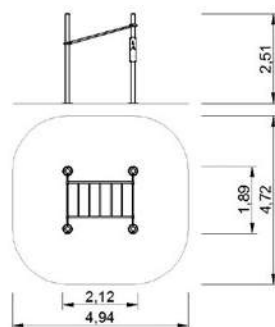

**Braqueador  
Brachiation ladder  
Brachiation**

**R7474D**





**Conjunto street workout 3 postes en "l"**  
 Set street workout 3 posts in "l"  
 Ensemble street workout 3 poteaux en "l"

**R7472**

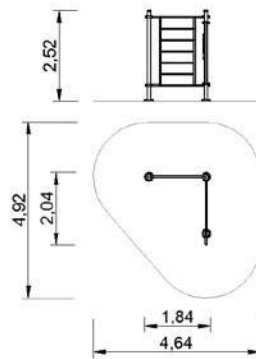

**Conjunto street workout 4 postes**  
 Set street workout 4 posts  
 Ensemble street workout 4 poteaux

**R7473**

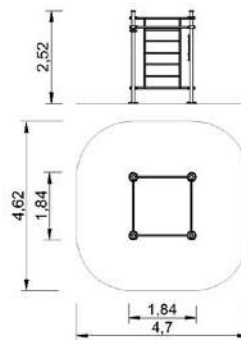

**Braqueador**  
 Brachiation ladder  
 Brachiation

**R7474**

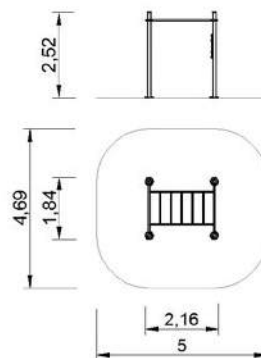

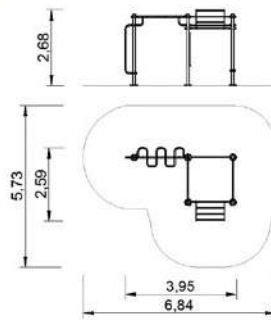
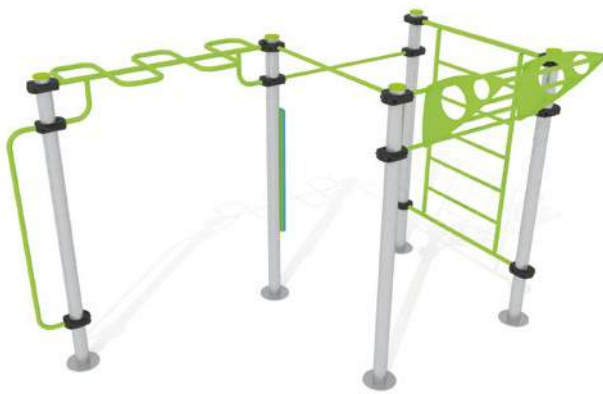

**Conjunto street workout 5 postes**  
Set street workout 5 posts  
Ensemble street workout 5 poteaux

**R7475**

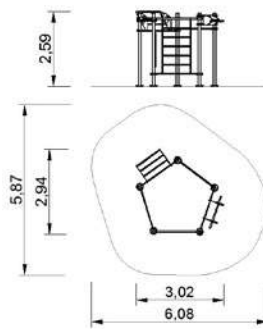

**Conjunto street workout 5 pentagonal**  
Set street workout pentagonal 5 posts  
Ensemble street workout  
5 Poteaux en pentagone

**R7476**

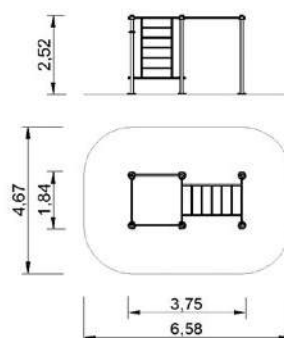

**Conjunto street workout 6 postes**  
Set street workout 6 posts  
Ensemble street workout 6 poteaux

**R7477**





**Conjunto street workout 7 postes**

Street workout set 7 posts  
 Ensemble street workout 7 poteaux

**R7464**

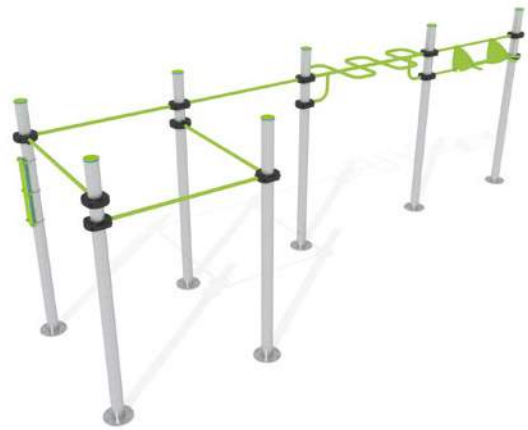
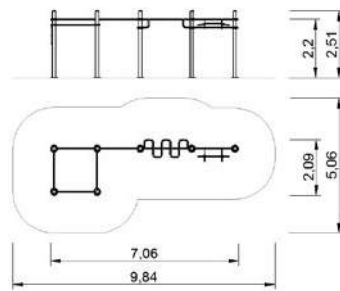

**Conjunto street workout 10 postes**

Street workout set 10 posts  
 Ensemble street workout 10 poteaux

**R7466**

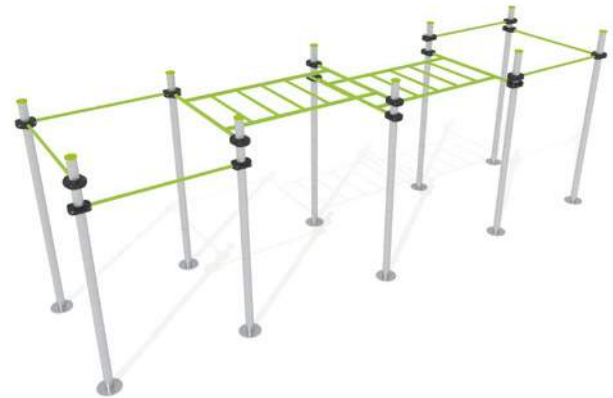
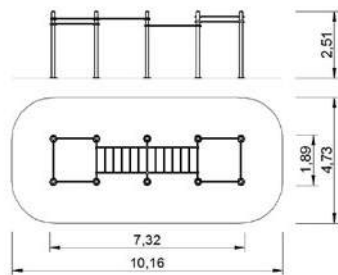

**Conjunto street workout 8 postes**

Street workout set 8 posts  
 Ensemble street workout 8 poteaux

**R7468**

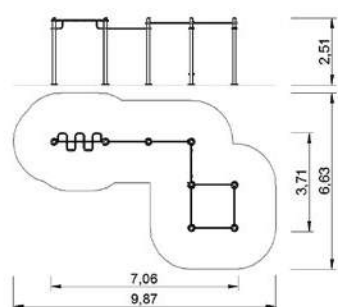



**Conjunto street workout 6 postes hexagonal**

Street workout hexagonal set 6 posts  
 Ensemble street workout  
 6 Poteaux en pentagone

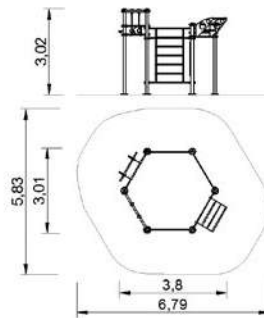

**R7478**



**Conjunto street workout 9 postes**

Street workout set 9 posts  
 Ensemble street workout 9 poteaux

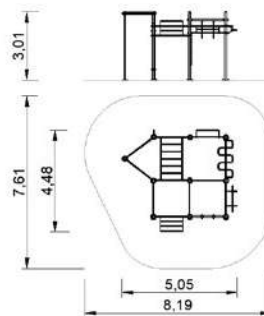

**R7479**

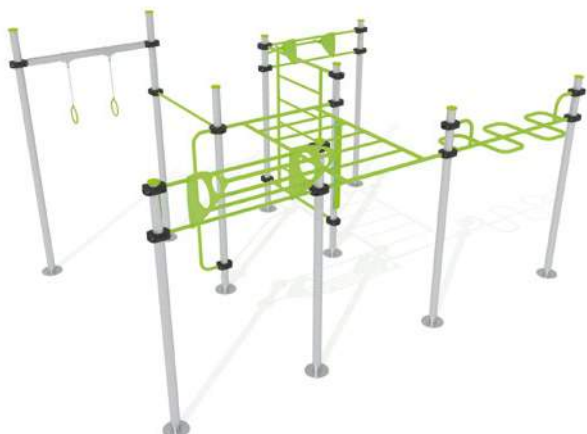

**Conjunto street workout 10 postes**

Street workout set 10 posts  
 Ensemble street workout 10 poteaux

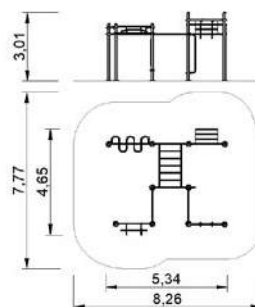

**R7480**



**Conjunto street workout 12 postes**  
 Street workout set 12 posts  
 Ensemble street workout 12 poteaux

**R7481**

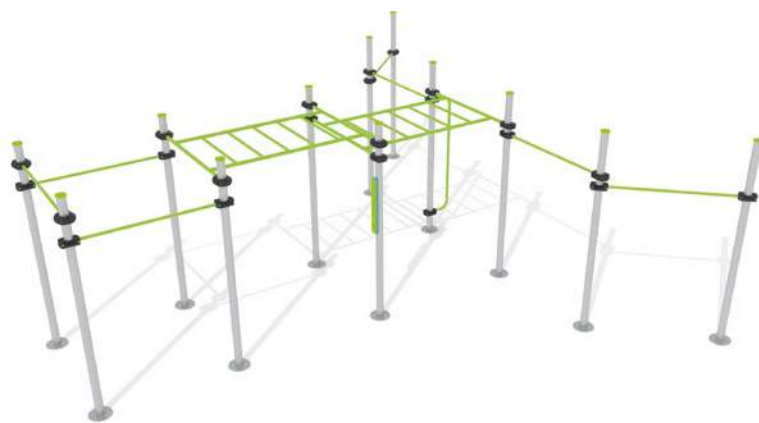
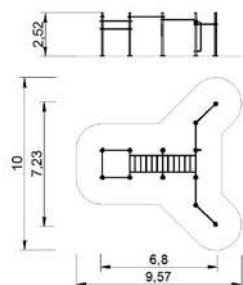

**Conjunto street workout 16 postes**  
 Street workout set 16 posts  
 Ensemble street workout 16 Poteaux

**R7483**

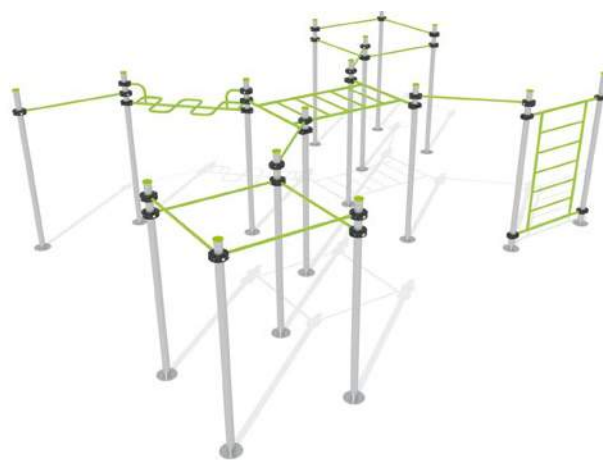
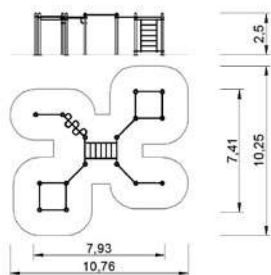

**Conjunto street workout 15 postes**  
 Street workout set 15 posts  
 Ensemble street workout 15 Poteaux

**R7485**

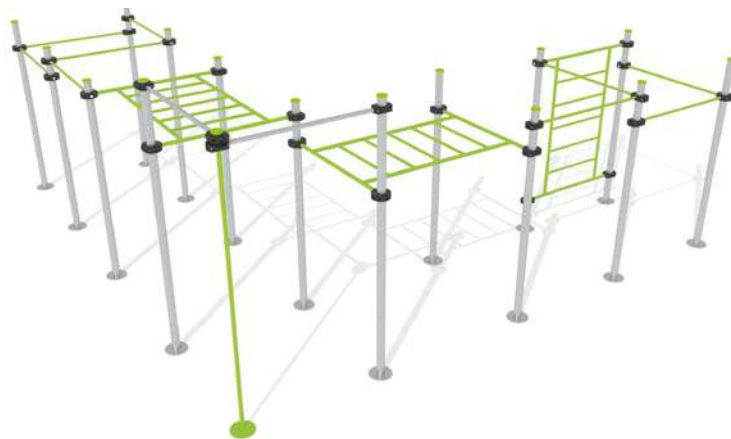
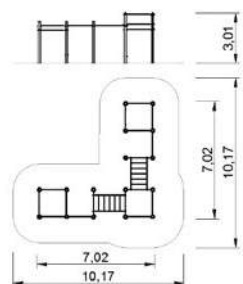

**Conjunto street workout 18 postes**  
 Street workout set 18 posts  
 Ensemble street workout 18 Poteaux

**R7487**

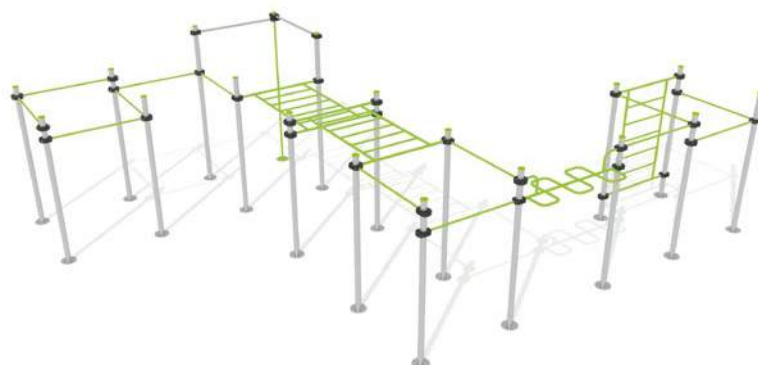
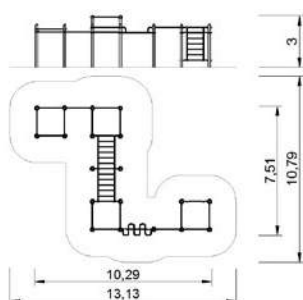







CIRCUITOS DEPORTIVOS / OUTDOOR SPORT CIRCUITS / CIRCUITS SPORTIFS  
**CONJUNTOS STREET / SET STREET / ENSEMBLE STREET**

	ÁREA RECOMENDADA RECOMMENDED AREA SURFACE RECOMMANDÉE	SUPERFICIES AMORTIGUADORAS VÁLIDAS (Ver requisitos EN-16630:2015) VALID SAFETY SURFACES (See requirements EN-16630:2015) / SURFACES AMORTISSANTES VALABLES (Voir exigences EN-16630:2015)			
		Altura de caída máxima Maximum free height of fall Hauteur de chute libre max.	Arena-Grava (Espesor 300mm) Sand-Gravel (Thickness 300mm) Sable-Gravier (Épaisseur 300mm)	Suelo continuo de caucho Wet pour Sol coulé amortissant	Baldosa R4400 (Espesor 45mm) Safety tiles R4400 (Thickness 45mm) Dalles R4400 (Épaisseur 45mm)
SYDNEY AREA	64 m <sup>2</sup>	1,35 m	✓	25-50 mm	✓
SEOUL AREA	90 m <sup>2</sup>	1,45 m	✓	25-55 mm	✗
ATLANTA AREA	144 m <sup>2</sup>	1,3 m	✓	25-45 mm	✓
MONTREAL AREA	169 m <sup>2</sup>	1,7 m	✓	25-65 mm	✗
ATHENS AREA	225 m <sup>2</sup>	2 m	✓	25-80 mm	✗

**SYDNEY AREA**

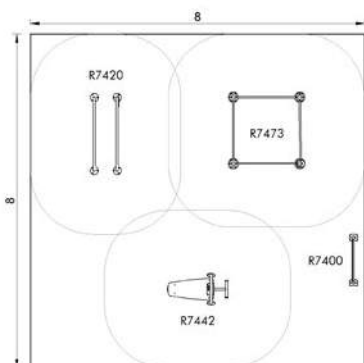

**SEOUL AREA**

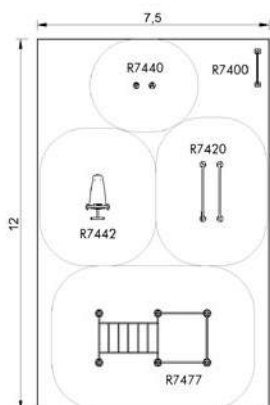



## ATLANTA AREA

EN-IG630 +14 años-years-ans

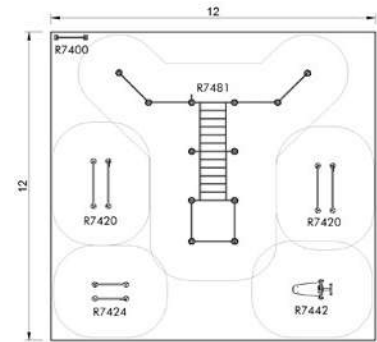

## MONTREAL ÁREA

EN-IG630 +14 años-years-ans

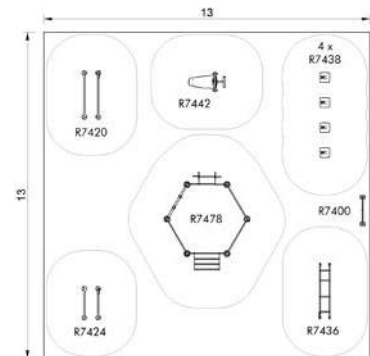

## ATHENS AREA

EN-IG630 +14 años-years-ans

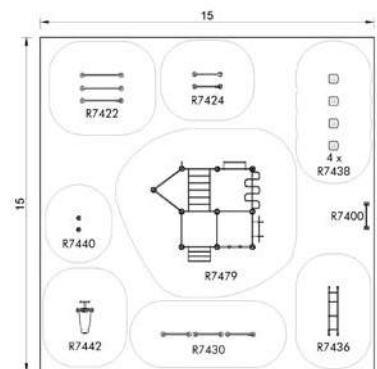



CIRCUITOS DEPORTIVOS / OUTDOOR SPORT CIRCUITS / CIRCUITS SPORTIFS  
**CONJUNTOS STREET / SET STREET / ENSEMBLE STREET**

	ÁREA RECOMENDADA RECOMMENDED AREA SURFACE RECOMMANDÉE	SUPERFICIES AMORTIGUADORAS VÁLIDAS (Ver requisitos EN-16630:2015) VALID SAFETY SURFACES (See requirements EN-16630:2015) / SURFACES AMORTISSANTES VALABLES (Voir exigences EN-16630:2015)			
		Altura de caída máxima Maximum free height of fall Hauteur de chute libre max.	Arena-Grava (Espesor 300mm) Sand-Gravel (Thickness 300mm) Sable-Gravier (Épaisseur 300mm)	Suelo continuo de caucho Wet pour Sol coulé amortissant	Baldosa R4400 (Espesor 45mm) Safety tiles R4400 (Thickness 45mm) Dalles R4400 (Épaisseur 45mm)
SINGAPUR AREA	94,5 m <sup>2</sup>	1,35 m	✓	25-50 mm	✓
NEW YORK AREA	110 m <sup>2</sup>	1,4 m	✓	25-50 mm	✓
TOKIO AREA	168 m <sup>2</sup>	2 m	✓	25-80 mm	✗
SAO PAULO AREA	180 m <sup>2</sup>	2 m	✓	25-80 mm	✗
LONDON AREA	201 m <sup>2</sup>	1,4 m	✓	25-50 mm	✓

**SINGAPUR AREA**

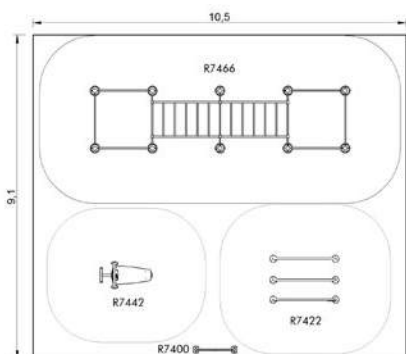

**NEW YORK AREA**

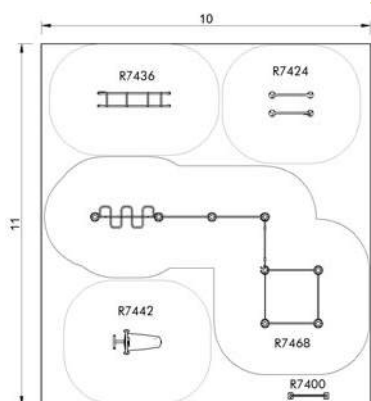



## TOKIO AREA

EN-16630 **+14**  
 años-years-ans

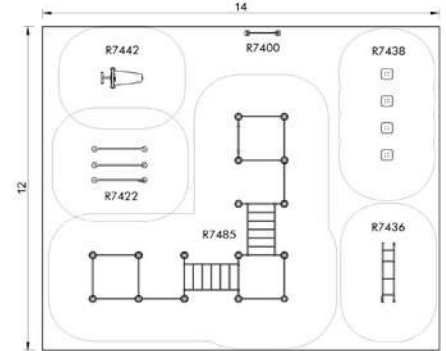

## SAO PAULO AREA

EN-16630 **+14**  
 años-years-ans

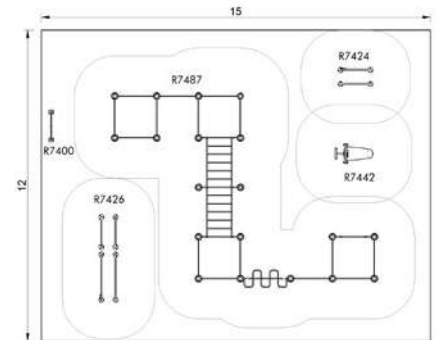

## LONDON AREA

EN-16630 **+14**  
 años-years-ans

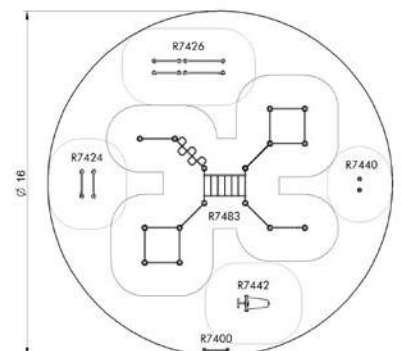



**Baja  
Low  
Basse** Intensidad  
Intensity  
Intensité

**+50** Años  
Years  
Ans



Informe médico disponible  
Medical test report available  
Dossier d'essai médical disponible





# Parque de mayores Senior Playground Parc d'activité physique pour Seniors

## PARQUE DE MAYORES

El envejecimiento es un proceso fisiológico que afecta a todos los sistemas de nuestro organismo y entre ellos, al aparato locomotor. Por esta razón, todas las personas sanas, y más aún las personas mayores, deberían tener una adecuada actividad física general y deportiva, muy eficaz para mantener el bienestar.

Nuestros mayores constituyen un sector de la población creciente. Pasan gran parte del día en las calles, paseando o cuidando de sus nietos mientras los padres trabajan. Tienen mucho tiempo, y pocas posibilidades de ocio al aire libre, especialmente gratuitas.

**El Parque de Mayores es una propuesta de entretenimiento que contribuye a que los mayores lleven una vida saludable** realizando ejercicio al aire libre mientras charlan o cuidan a los más pequeños. Es un proyecto social que pretende mejorar su calidad de vida, y que, por su diseño modular, es una inversión al alcance de Administraciones Públicas y Centros Privados.

Se proponen unos **aparatos muy eficaces, de bajo impacto para prevenir lesiones**. Están diseñados para mantener y mejorar la amplitud particular de la mayoría de las articulaciones del cuerpo, la fuerza de las piernas, el equilibrio y la marcha. Esto, unido a su instalación al aire libre, permite, además de entretener, mejorar el bienestar físico, psíquico y social de la persona.

**Los aparatos han sido desarrollados íntegramente por un médico rehabilitador y fisioterapeuta.**

Todos los elementos están certificados en el cumplimiento de la **Norma EN16630:2015**, que establece los requisitos de seguridad y métodos de ensayo de los equipos fijos de entrenamiento físico instalados al aire libre.

Fabricado en polietileno de alta densidad, antigraffiti, libre de mantenimiento.

Mecanismos de acero inoxidable y polietileno.

Partes metálicas en acero de alta calidad [acero inoxidable, galvanizado, cataforesis, etc].

## SENIOR PLAYGROUNDS

Aging is a physiological process that affects all systems of the body and among them the locomotor system. For this reason, all healthy people, and even more seniors, should do adequate physical activity and sport, which is very effective in maintaining wellness.

Our seniors are a growing segment of the population. They spend much of the day in the streets, walking or caring for grandchildren while parents work. They have plenty of time, and little chance of outdoor recreation, especially for free.

**The Senior Playground is an entertainment proposal that helps seniors lead healthy lives** by exercising outdoors while chatting or looking after children.

It is a project that aims at improving their quality of life and, thanks to its modular design, is an investment affordable to governments and private centers.

We propose **effective, low impact machines to avoid injury**. They are designed to maintain and improve the range of motion of most joints in the body, leg strength, balance and walking position. This, together with its outdoor installation, as well as being fun, improves the physical, mental and social well being of the individual.

**The units have been fully developed by a rehabilitation doctor and a physiotherapist.**

All units are certified in compliance with European Standard **EN16630:2015**, which sets the safety requirements and test methods of permanently installed outdoor fitness equipment. Stainless steel and polyethylene mechanisms High quality steel parts (stainless steel, galvanized, cataphoresis, etc).

Manufactured with anti-graffiti, maintenance free HDPE.

## PARC POUR SENIORS

Le vieillissement est un processus physiologique qui affecte tous les systèmes de notre organisme et en particulier l'appareil locomoteur. Pour cette raison, toutes les personnes saines et à plus forte raison les seniors devraient avoir une activité physique générale et sportive adéquate, essentielle pour maintenir le bien-être.

Nos seniors constituent une frange de la population en constant accroissement. Ils passent une grande partie de la journée dehors, promenant ou prenant soin de leurs petits enfants pendant que leurs parents sont au travail. Ils disposent de beaucoup de temps et de peu de possibilités de loisirs à l'air libre, particulièrement gratuits.

**Le Parc d'activité physique pour Seniors est une proposition de distraction qui contribue à ce que les seniors aient une vie salubre** en réalisant des exercices en plein air pendant qu'ils discutent ou prennent soin des plus petits.

C'est un projet social qui prétend améliorer leur qualité de vie et qui par sa conception modulaire représente un investissement à la portée des Administrations Publiques ou Centres privés.

Nous proposons des **appareils efficaces et à faible impact, pour prévenir des blessures**. Ils sont conçus pour maintenir et améliorer l'amplitude articulaire de la plupart des articulations du corps, de la force des jambes, de l'équilibre et de la marche. Ceci, allié à leur installation en plein air, permet en plus de la distraction une amélioration du bien-être physique, psychique et social de la personne.

**Les appareils ont été développés de manière intégrale par un médecin rééducateur et physiothérapeute.**

Tous les articles ont été certifiés conformes à la norme européenne **EN 16630: 2015**, qui spécifie les exigences de sécurité et méthodes d'essai des modules fixes d'entraînement physique de plein air en accès libre.

Fabriqué en polyéthylène de haute densité, antigraffiti et sans entretien. Les mécanismes sont réalisés en acier inoxydable et polyéthylène. Les parties métalliques sont en acier de haute qualité [acier inoxydable, acier galvanisé, cataphorèse, etc]. (acier inoxydable, acier galvanisé, cataphorèse, etc).



Galería de fotos  
Photo gallery  
Galerie de photos



CIRCUITOS DEPORTIVOS / OUTDOOR SPORT CIRCUITS / CIRCUITS SPORTIFS  
**PARQUE DE MAYORES / SENIOR PLAYGROUND /**  
**PARC D'ACTIVITÉ PHYSIQUE POUR SENIORS**



R7100



R7110



R7120



R7120D



R7122



R7122D



R7125



R7125D



R7142



R7142D



R7144



R7144D



R7145



R7145D



R7155



R7160D



R7115

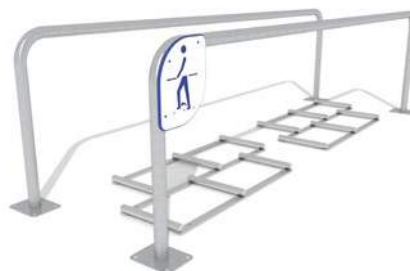

R7150



R7152





R7126SR



R7127SR



R7131SR



R7134SR



R7136SR



R7128



R7132



R7133



R7135



R7139



R7160



R7170



R7173



R7174



R7130



R7164

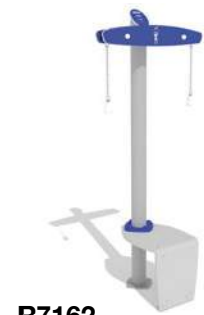

R7162



R7162D



R7165



R7166



R7167



**Cartel general**  
 General Sign  
 Panneau d'information générale

R7100

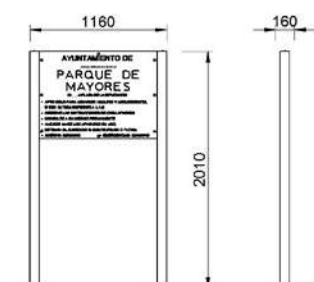

**Módulo de espaldera**  
 Back stretching station  
 Module dorsal

R7110

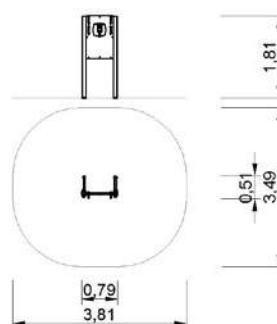

**Mampara con escalerilla de hombro y dedos**  
 Shoulder and finger stairs station  
 Panneau avec petit escalier pour épaule et doigts

R7120

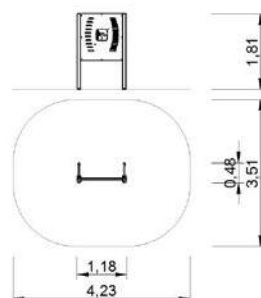

**Mampara adaptada con escalerilla de hombro y dedos**  
 Handicapped-ready station with shoulder and finger stairs  
 Panneau avec petit escalier pour épaule et doigts. Accessible PMR

R7120D

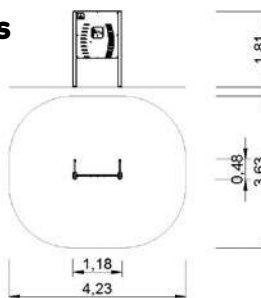

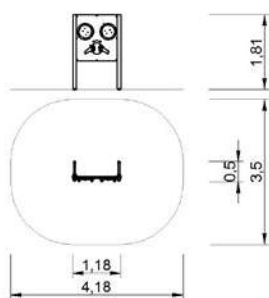

**Mampara con laberintos**  
 Labyrinths station  
 Panneau avec labyrinthes

R7122

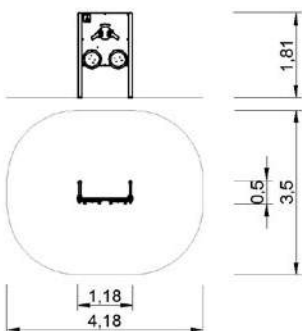

**Mampara adaptada con laberintos**  
 Handicapped-ready station with labyrinths  
 Panneau avec labyrinthes. Accessible PMR

R7122D

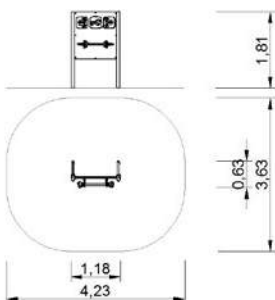

**Mampara con rodillo giratorio**  
 Turning roller station  
 Panneau avec rouleau rotatif

R7125

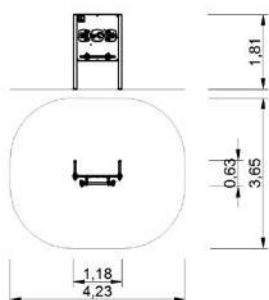

**Mampara adaptada con rodillo giratorio**  
 Handicapped-ready station with turning roller  
 Panneau avec rouleau rotatif. Accessible PMR

R7125D



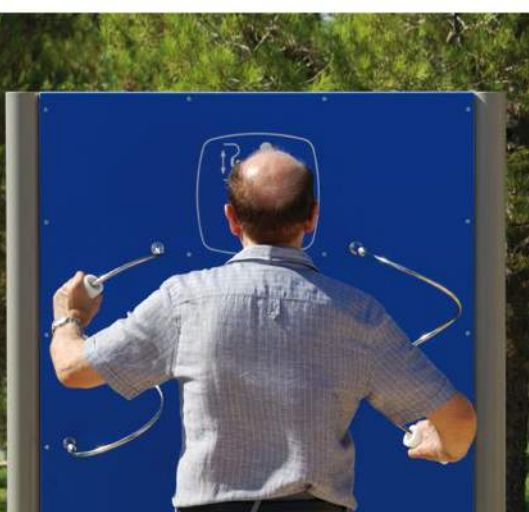

**Mampara con doble hélice**

Double helix for wrist work station  
 Panneau avec double hélice

**R7142**

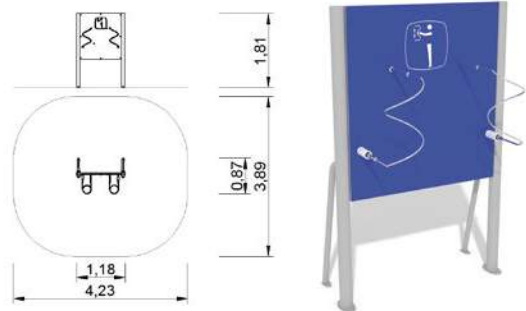

**Mampara adaptada con doble hélice**

Handicapped-ready station with double helix  
 for wrist work  
 Panneau avec double hélice. Accessible PMR

**R7142D**

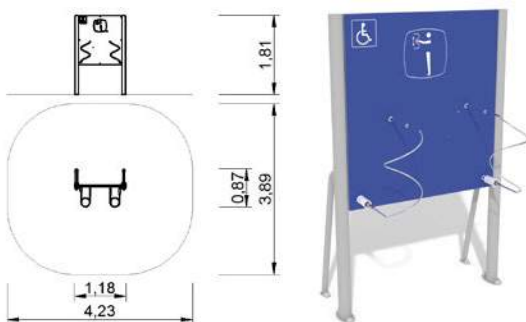

**Mampara con giro de muñeca y ejercicio de puños**

Wrist turning and fist work station  
 Panneau avec rotation du poignet  
 et exercice des poings

**R7144**

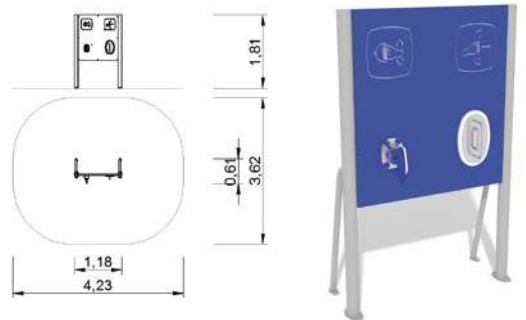

**Mampara adaptada con giro de muñeca y ejercicio de puños**

Handicapped-ready station with wrist turning  
 and fist work  
 Panneau avec rotation du poignet et exercice  
 des poings. Accessible PMR

**R7144D**

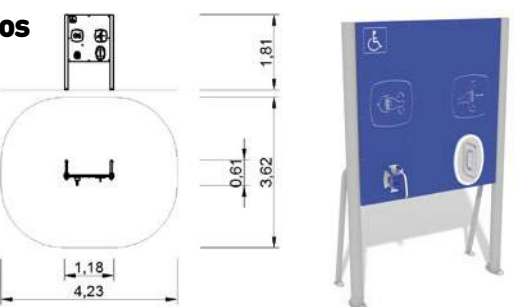

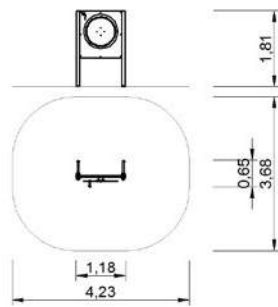

**Mampara con rueda de hombro**  
 Shoulder wheel station  
 Panneau avec roue d'épaule

R7145

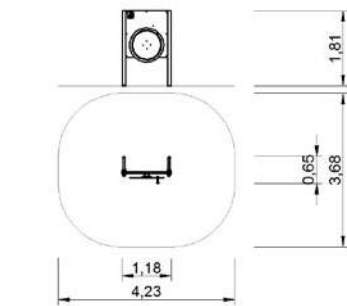

**Mampara adaptada con rueda de hombro**  
 Handicapped-ready station with shoulder wheel  
 Panneau avec roue d'épaule. Accessible PMR

R7145D

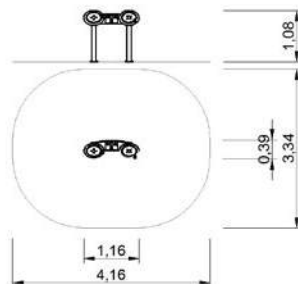

**Ruedas de brazos**  
 Tai chi spinners  
 Roues pour bras

R7155

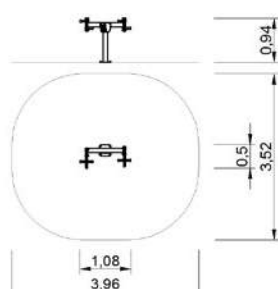

**Doble bicicleta de brazos adaptada**  
 Handicapped-ready station with  
 double hand bike  
 Double bicyclette à bras. Accessible PMR

R7160D





**Pasarela con rampa y escaleras**  
 Walkway with ramp and stairs  
 Passerelle avec rampe et escaliers

R7115

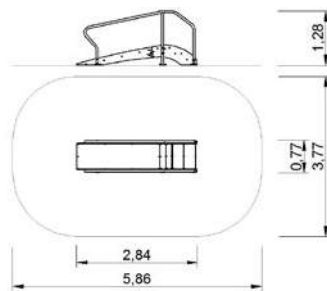

**Paso de obstáculos**  
 Obstacle walkway  
 Passage d'obstacles

R7150

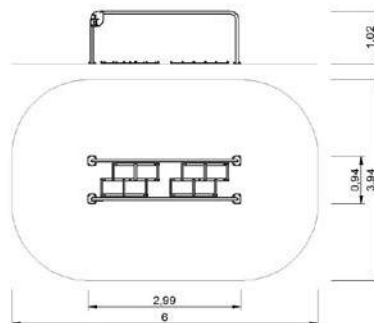

**Paso de obstáculos móvil**  
 Moving obstacle walkway  
 Passage d'obstacles mobiles

R7152

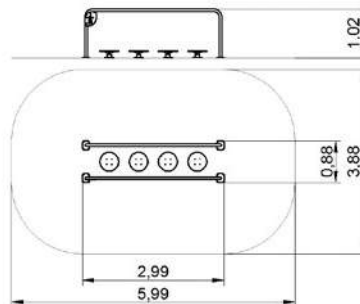

**Sillón reciclado con circuito 1-7 psicomotriz**  
 Armchair with 1-7 psychomotor circuit  
 Fauteuil avec circuit 1-7 psychomoteur

R7126SR

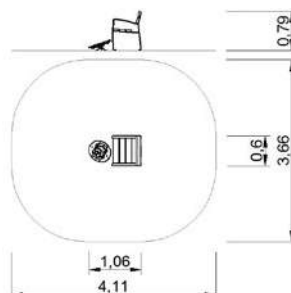

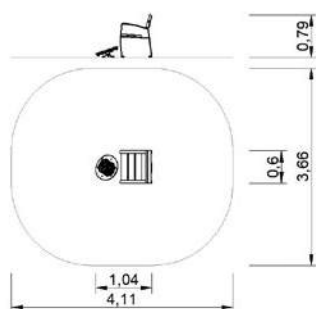

**Sillón reciclado con laberinto psicomotriz**  
 Armchair with psychomotor labyrinth  
 Fauteuil avec labyrinthe psychomoteur

R7127SR

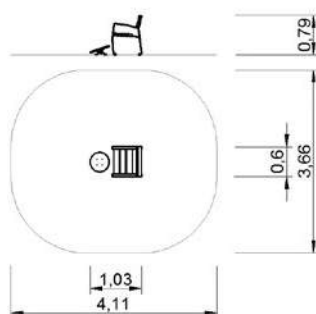

**Sillón con plato de Böhler**  
 Armchair with böhler's ankle rotation platform  
 Fauteuil avec disque Böhler

R7131SR

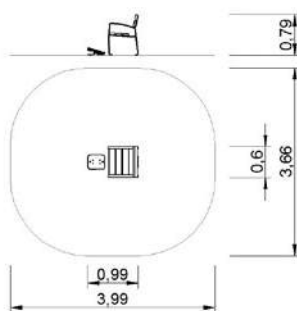

**Sillón con tabla de Freeman**  
 Armchair with Freeman's board  
 Fauteuil avec planche de Freeman

R7134SR

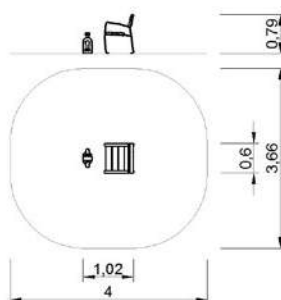

**Sillón con bicicleta**  
 Recumbent bike  
 Fauteuil avec pédale

R7136SR





**Banco con doble plato psicomotriz**  
 Bench with double psychomotor discs  
 Banc avec double plateau psychomoteur

R7128

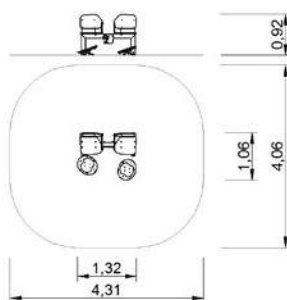

**Banco con doble plato de böhler**  
 Bench with double böhler's  
 ankle rotation platforms  
 Banc avec double disque böhler

R7132

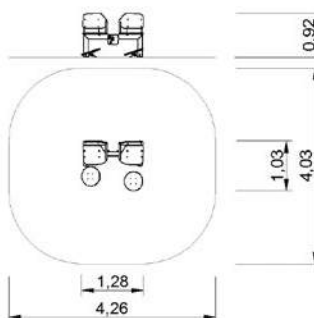

**Banco con doble tabla de freeman**  
 Bench with double freeman's board  
 Banc avec double planche de freeman

R7133

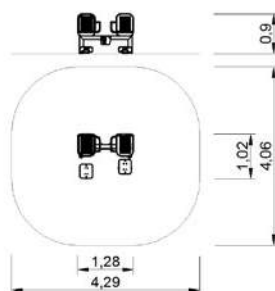

**Banco doble con pedales**  
 Double recumbent bike  
 Banc double avec pédales

R7135

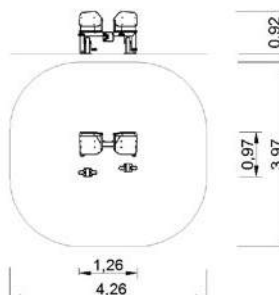



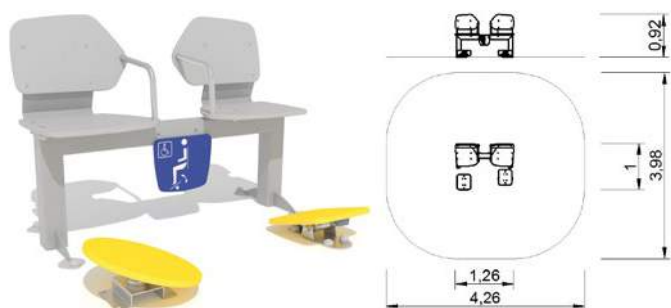

**Banco con plato de Böhler y tabla Freeman**  
 Bench with Böhler's platform  
 and Freeman's board  
 Banc avec disque Böhler et planche Freeman

R7139

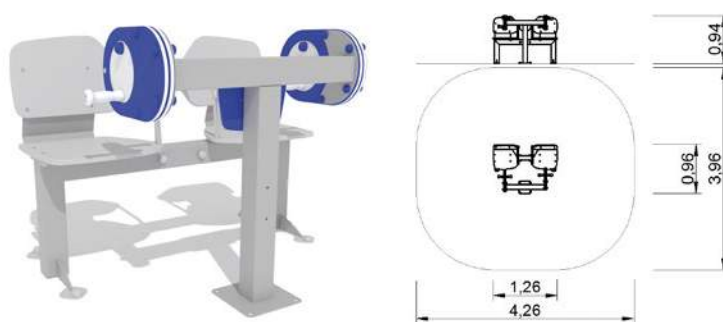

**Banco con doble bicicleta de brazos**  
 Bench with double hand bike  
 Banc avec double bicyclette à bras

R7160

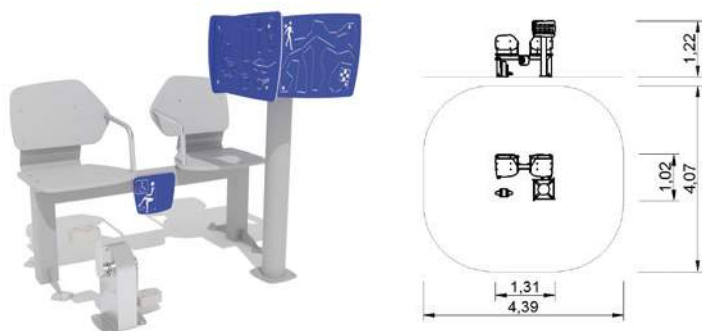

**Banco con pedales y Mentalcube I para Alzheimer**  
 Bench with bike and Mentalcube I for Alzheimer  
 Banc avec pédale et Mentalcube I pour Alzheimer

R7170

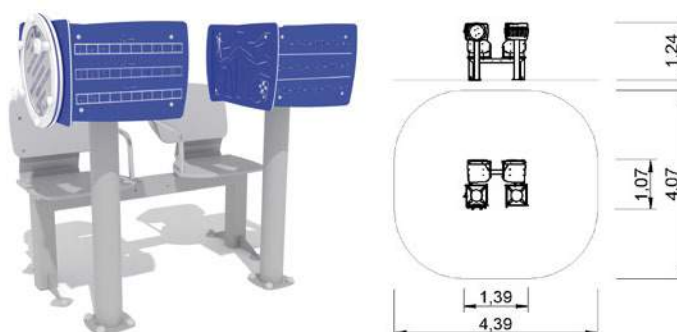

**Banco con doble Mentalcube para Alzheimer**  
 Bench with double Mentalcube for Alzheimer  
 Banc avec double Mentalcube pour Alzheimer

R7173





**Banco con pedales y Mentalcube II para Alzheimer**

Bench with bike and Mentalcube II for Alzheimer  
 Banc avec pédale et Mentalcube II pour Alzheimer

R7174

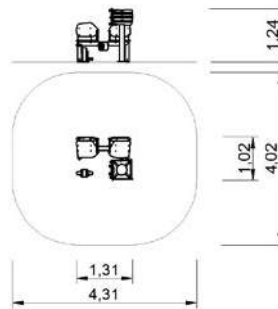

**Doble giro de cintura**

Double waist turning station  
 Double rotation de la ceinture

R7130

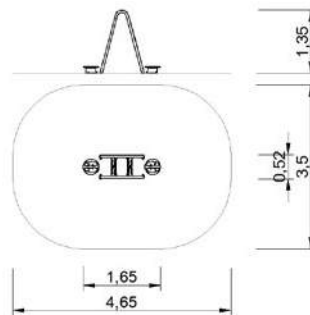

**Asiento de equilibrio**

Balance seat  
 Siège pour l'équilibre

R7164

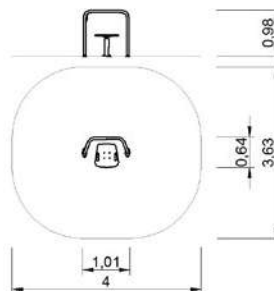

**Autopasivo**

Self passive  
 Autopassif

R7162

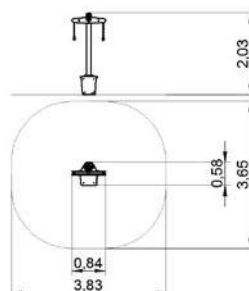

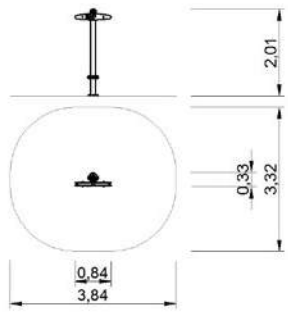

**Autopasivo adaptado**  
 Handicapped-ready station with Self passive  
 Autopassif. Accessible PMR

**R7162D**

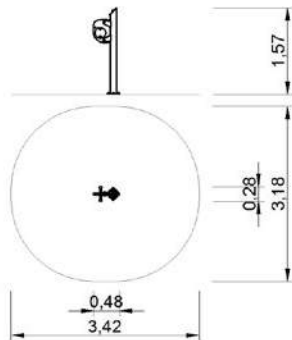

**Bicicleta de brazos**  
 Arm bike  
 Bicyclette à bras

**R7165**

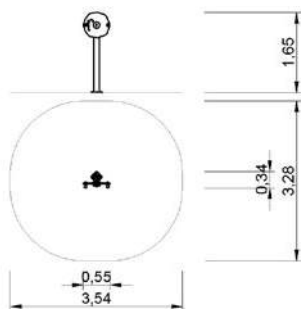

**Rueda de hombro**  
 Shoulder wheel  
 Roue d'épaule

**R7170**

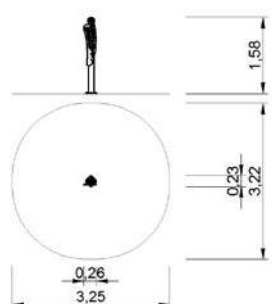

**Escalera de hombro y dedos**  
 Finger and shoulder ladder  
 Escalier pour épaule et doigts

**R7167**









PATENTADO  
Patented  
Breveté



Alta  
High  
Haute

Intensidad  
Intensity  
Intensité

+14

Años  
Years  
Ans



Informe médico disponible  
Medical test report available  
Dossier d'essai médical disponible





# Gimnasio en la calle

## Outdoor gym

### Gym en plein air



#### GIMNASIO EN LA CALLE

El ejercicio físico sistemático mejora la salud y contribuye decisivamente a la longevidad, actuando en la mayoría de los sistemas de nuestro organismo. Desde Industrias Agapito, proponemos el Gimnasio en la Calle porque es la forma ideal de hacer ejercicio al aire libre y porque con nuestros aparatos se realizan **ejercicios que mejoran la flexibilidad, el equilibrio, la capacidad respiratoria y la resistencia.**

**Se trata de aparatos de gran robustez, preparados contra el vandalismo y la intemperie,** fabricados con acero galvanizado con pintura de poliéster termoendurecida, paneles de polietileno de alta densidad anti-grafitti, con revestimiento de caucho antideslizante en piezas de apoyo.

Todos los elementos son de fabricación propia, con un diseño vanguardista e innovador, y un **mecanismo patentado** totalmente oculto en cajón cerrado bajo asiento que elimina todos los puntos de atrapamiento.

Los aparatos han sido desarrollados con la colaboración de un médico rehabilitador y están **certificados en el cumplimiento de la Norma EN16630:2015, que establece los requisitos de seguridad y métodos de ensayo de los equipos fijos de entrenamiento físico instalados al aire libre.**

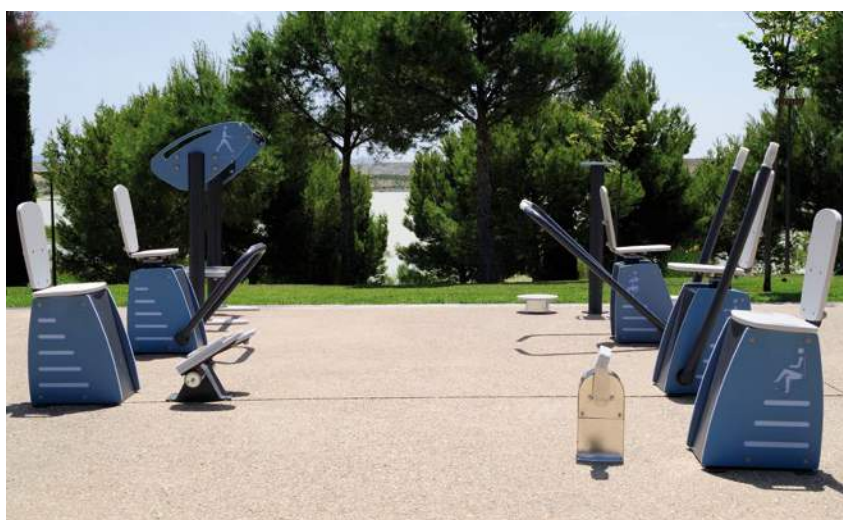

#### OUTDOOR GYM

Systematic physical exercise improves health and contributes decisively to longevity, acting on most of our body systems.

We propose the Outdoor Gym because it is the ideal way of exercising outdoors and because with our equipment you can perform **exercises that improve flexibility, balance, respiratory capacity and resistance.**

**The equipment is robustly built and prepared against vandalism and to endure outdoor conditions.**

Manufactured with thermo-hardened painted galvanized steel, anti-graffiti HDPE panels, and anti slippery rubber covered HDPE body support parts. All the elements are manufactured by Industrias Agapito, with an innovative design, and a **patented mechanism** hidden under the seat to eliminate all entrapment risks.

All stations have been developed by a rehabilitation physician and are **certified in compliance with European Standard EN16630:2015, which sets the safety requirements and test methods of permanently installed outdoor fitness equipment.**

#### GYM EN PLEIN AIR

L'activité physique quotidienne améliore la santé et contribue de manière décisive à la longévité, en agissant sur la plupart des systèmes de notre corps. Industrias Agapito propose Gym en plein air pour faire du sport à l'extérieur. Les appareils que nous proposons permettent de réaliser des **exercices pour améliorer la flexibilité, l'équilibre, la capacité respiratoire et la résistance.**

**Ils sont produits dans des matériaux très robustes, résistants au vandalisme et aux intempéries.** Ils sont réalisés en acier galvanisé et thermo-laqué, avec des panneaux en polyéthylène HPDE antigraffiti et pour les zones d'appui antidérapant.

Tous les éléments sont fabriqués par Industrias Agapito, avec un design moderne et innovant, un **mécanisme breveté** caché sous le siège pour éviter tout coincement.

Tous les appareils ont été développés par un médecin spécialisé en rééducation et ils sont **certifiés conformes à la norme européenne EN 16630: 2015, qui spécifie les exigences de sécurité et méthodes d'essai des modules fixes d'entraînement physique de plein air en accès libre.**



Galería de fotos  
Photo gallery  
Galerie de photos



R7200



R7210



R7226



R7232



R7236



R7240



R7242



R7246



R7258



R7259



R7262



R7263



R7264



R7266



R7270



R7272



R7275



R7278



R7285



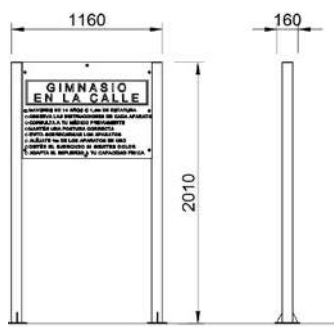

**Cartel general**  
 General Sign  
 Panneau d'information générale

**R7200**

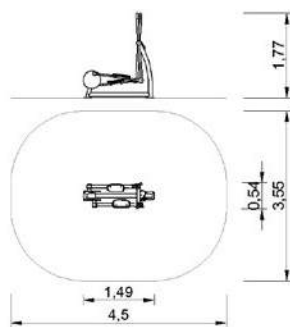

**Andador elíptico**  
 Elliptical cross-trainer  
 Marcheur elliptique

**R7210**

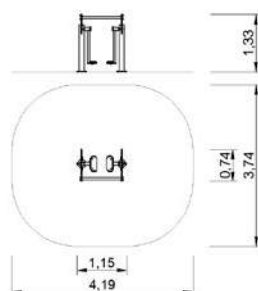

**Andador en suspensión**  
 Sky walker station  
 Marcheur suspendu

**R7226**

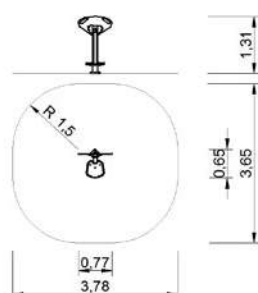

**Péndulo**  
 Swinger station  
 Pied oscillant

**R7232**





**Giro de cintura**  
 Waist turning station  
 Rotation de la ceinture

**R7236**

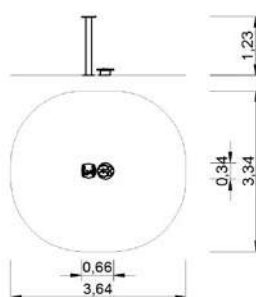

**Step**  
 Step  
 Step

**R7240**

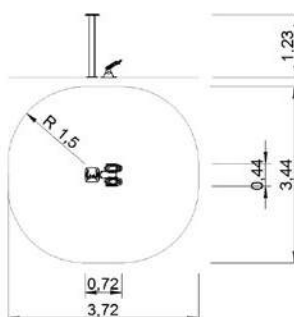

**Aparato de gemelos**  
 Calf exercise machine  
 Appareil de musculation des mollets

**R7242**

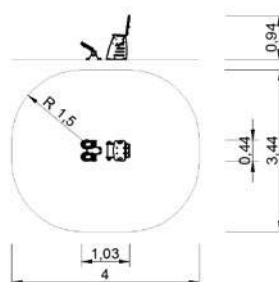

**Bicicleta**  
 Bike  
 Bicyclette

**R7246**

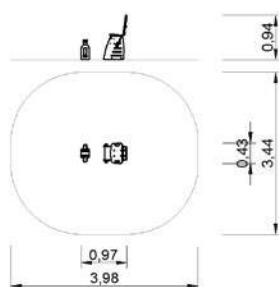

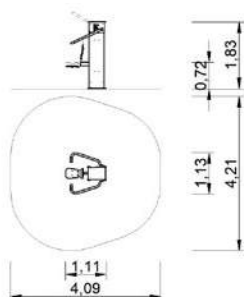

**Prensa de hombros**  
 Shoulder press  
 Presse à épaules

**R7258**

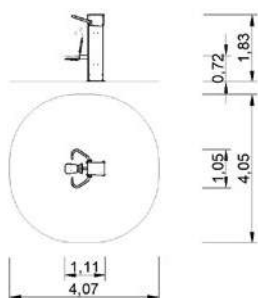

**Aparato de dorsales**  
 Pulldown  
 Appareil à dorsaux

**R7259**

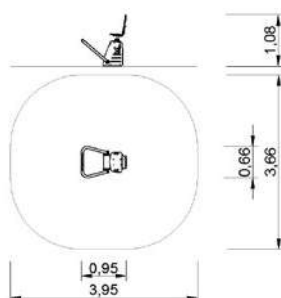

**Prensa de piernas**  
 Leg press  
 Presse à jambes

**R7262**

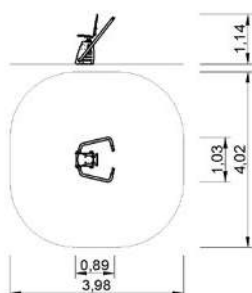

**Remo y dorsales**  
 Rowing machine and lat pull station  
 Rameur et musculation du dos

**R7263**





**Press banca sentado**  
 Seated chest press  
 Banc press assis

**R7264**

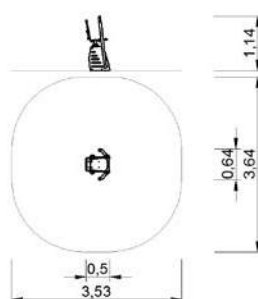

**Plato de rotación de hombros**  
 Tai chi spinners  
 Disque de rotation des épaules

**R7266**

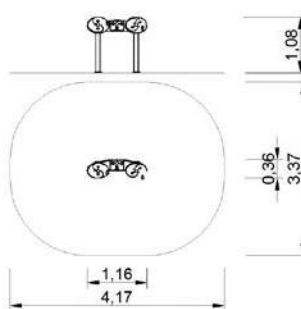

**Banco de abdominales**  
 Sit up bench  
 Banc à abdominaux

**R7270**

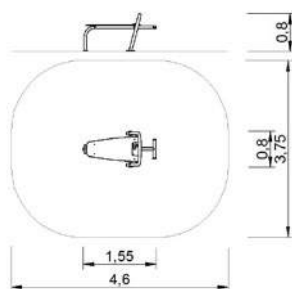

**Torre 10 ejercicios**  
 10 exercise station  
 Station 10 exercices

**R7272**

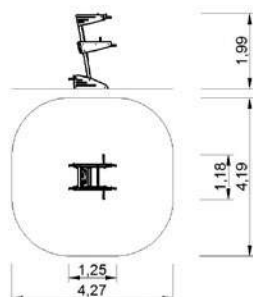

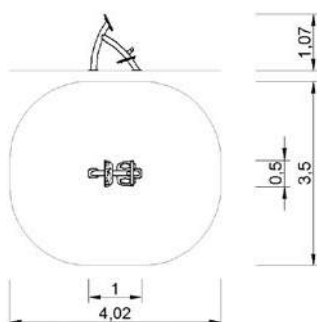

**Aparato de extensión lumbar**  
 Lower back bench  
 Appareil d'extension lombaire

**R7275**

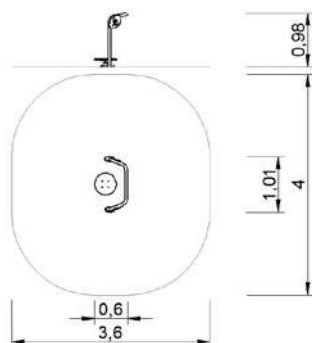

**Plato de equilibrio**  
 Balancing squats  
 Flexion sur jambes

**R7278**

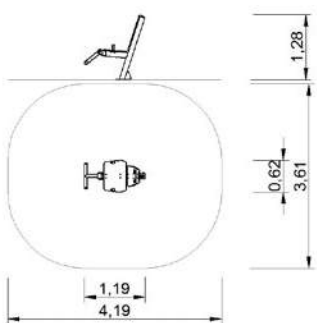

**Flexo-extensión de piernas**  
 Leg curl and extension station  
 Flexo-extension des jambes

**R7285**













# Circuito Nforma

## Nforma Circuit

### Circuit Nforme



#### CIRCUITO N-FORMA

Circuito compacto, muy completo, en dos configuraciones, hexagonal y zig-zag.

**Materiales específicos para su instalación en playas y otros entornos agresivos**, y por supuesto en cualquier otro emplazamiento. Fabricado íntegramente en **acero inoxidable AISI316 y polietileno de alta densidad**, antigraffiti, libre de mantenimiento.

Avalado por médico rehabilitador y fisioterapeuta colegiados.

Todos los elementos están certificados en el cumplimiento de la **Norma EN16630:2015**, que establece los requisitos de seguridad y métodos de ensayo de los equipos fijos de entrenamiento físico instalados al aire libre.



#### N-FORMA CIRCUIT

A very complete compact circuit, with two different configurations: hexagonal and zig-zag.

**Specific materials to be installed directly on the beach or other aggressive environments** and, of course, at any other place.

Entirely manufactured with **AISI316 stainless steel and anti-graffiti, maintenance free HDPE**. Backed by qualified rehabilitation physicians and physical therapists.

All units are certified in compliance with European Standard **EN16630:2015**, which sets the safety requirements and test methods of permanently installed outdoor fitness equipment.



#### CIRCUIT NFORME

Circuit compact, très complet, en deux combinaisons différentes: hexagonale et en zig-zag.

Utilisation de **matériaux spécifiques pour être installés directement sur des plages ou des environnements agressifs**, et bien sûr, dans tout autre emplacement.

Fabriqué entièrement en **acier inoxydable AISI316 et polyéthylène de haute densité**, antigraffiti et sans entretien.

Avalisé par des médecins rééducateurs et physiothérapeutes reconnus.

Tous les articles ont été certifiées conformes à la norme européenne **EN 16630: 2015**, qui spécifie les exigences de sécurité et méthodes d'essai des modules fixes d'entraînement physique de plein air en accès libre.



Intensidad  
Intensity  
Intensité



Años  
Years  
Ans



Informe médico disponible  
Medical test report available  
Dossier d'essai médical disponible



**Circuito Nforma hexagonal**  
 N-forma hexagonal circuit  
 Circuit Nforme hexagonal

**R7301X**

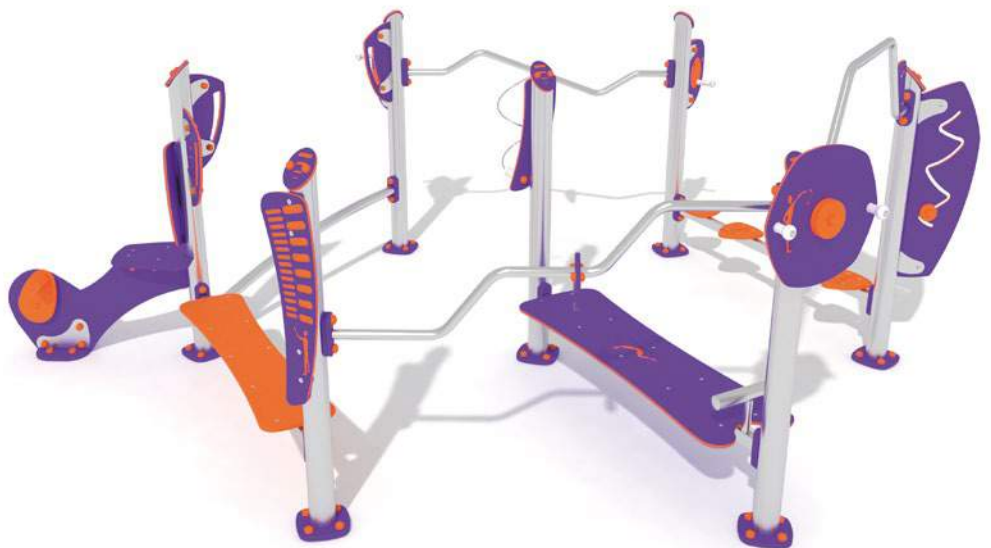
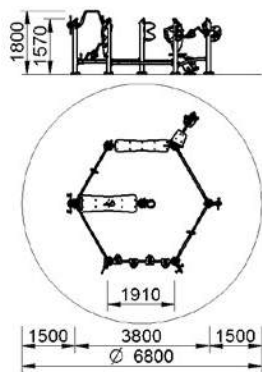

- 
- 
-  N° usuarios  
Users  
Nombre  
d'utilisateurs
-  Apto para playas  
Beach suitable  
Apte pour installation  
sur des plages

**Circuito Nforma Zig-Zag**  
 N-forma Zig-Zag  
 Circuit Nforme Zig-Zag

**R7302X**

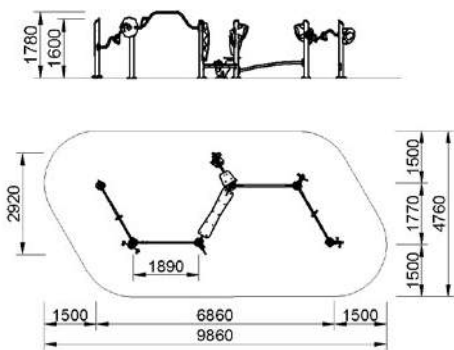

- 
- 
-  N° usuarios  
Users  
Nombre  
d'utilisateurs
-  Apto para playas  
Beach suitable  
Apte pour installation  
sur des plages



**Elementos Individuales**  
 Individual elements  
 Éléments individuels

**R7301X**  
**R7302X**



Escalera de hombro y dedos  
 Finger and shoulder ladder  
 Escalier pour épaule et doigts



Zig-zag de brazos  
 Arm zigzag board  
 Zig-zag de bras



Abdominales  
 Sit-ups  
 Banc à abdominaux



Puntos de equilibrio  
 Balance beam  
 Points d'équilibre



Flexiones verticales  
 Pull-ups  
 Barre à flexions verticale



Step y banco de estiramientos  
 Stretching bench and step  
 Step et banc d'étirement



Barra anilla sube y baja  
 Up and down ring bar  
 Barre-anneau monter et descendre



Barra anilla zigzag  
 Zigzag ring bar  
 Barre-anneau zigzag



Barra de salto lateral  
 Side jump bar  
 Double barre de saut latéral



Contractor y rotador de manos  
 Hand contractor and rotator  
 Contraction et rotation des mains



Giro de muñeca  
 Wrist twister  
 Wrist twister



Rueda de hombro  
 Shoulder wheel  
 Roue d'épaule



Hélice  
 Spiral  
 Hélice



Bicicleta  
 Bicycle  
 Bicyclette



Bicicleta de brazos  
 Arm bike  
 Bicyclette à bras

Circuitos deportivos / Outdoor sport circuits / Circuits sportifs  
Pista Multideporte / Multisport Courses / Terrain Multisports

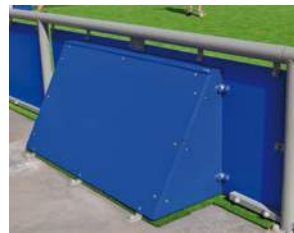

# Pista Multideporte

## Multisport Courses

### Terrain Multisports



#### PISTA MULTIDEPORTE

Las Pistas Multideporte son la solución perfecta para ubicar varios deportes en un espacio reducido.

Fútbol y baloncesto son los deportes estándar siempre incluidos, y opcionalmente pueden equiparse para tenis, voleibol y hockey, así como césped artificial o pintado de líneas.

Certificadas por TÜV SUD bajo la Norma EN 15312, están fabricadas en materiales de altísima calidad que las dotan de gran resistencia y un mínimo mantenimiento: polietileno de alta densidad bicolor, con posibilidad de realizar grabados personalizados, y estructura de acero galvanizado en caliente. Atenuación acústica para golpes de balón.



#### MULTISPORT COURSES

Multisport Courses MUGAs are the perfect solution to practice several sports on a reduced area.

Soccer and basketball are standard, tennis, volleyball and hockey can be optionally added, as well as artificial grass or line painting.

Certified by TÜV SUD under EN 15312 Standard, MUGAs are manufactured with the highest quality materials: hot-deep galvanized steel and bi-colored high density polyethylene, that allows personalized engravings. Acoustic attenuation against ball hits.

#### TERRAIN MULTISPORTS

Le terrain multisports représente la solution idéale pour pratiquer plusieurs sports sur une surface réduite.

Le football et le basket sont les sports inclus dans la version standard du terrain multisports, que peut éventuellement être équipé pour le tennis, le volley-ball et de hockey, ainsi que le gazon artificiel.

Certiés par TÜV SÜD conforme à la norme EN 15312, les multisports sont fabriqués avec des matériaux de haute qualité qui leur procurent une résistance élevée et une faible maintenance: polyéthylène haute densité bicolor, qui permet la réalisation de gravures personnalisées, et structure en acier galvanisé à chaud.



Acero galvanizado  
Galvanized steel  
Acier galvanisé





**Pista Multideporte**  
 Multisport Ground  
 Terrain Multisports

**R6400/R6400H**



40x20m

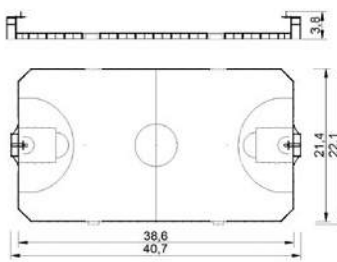

**R6402/R6402H**



30x15m

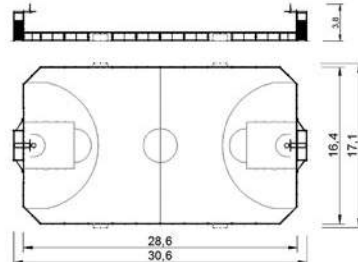

**R6404/R6404H**



20x10m

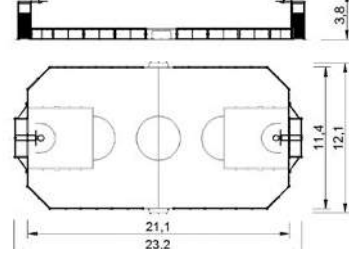

**R6400H / R6402H / R6404H**

**R6400 / R6402 / R6404**



**Agility Ladder**



**R6414**



### Streetball Game

R6410

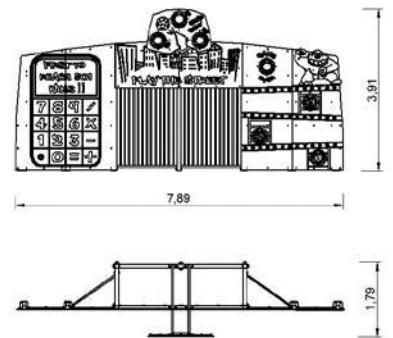

### Streetball Futsal

R6412

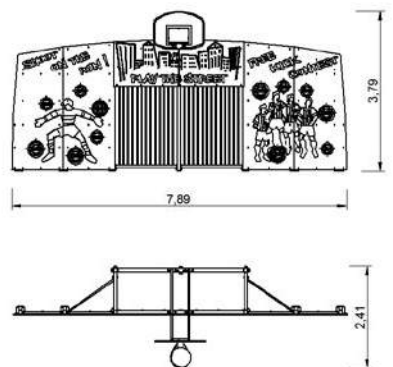







# Circuito Vita

## Vita Circuit

### Circuit Vita



#### CIRCUITO VITA

Circuito clásico de entrenamiento. Materiales y estética para entornos naturales. Fabricado en Pino Rojo del Norte con tratamiento en autoclave nivel P4 y protector láser a poro abierto. Barras y anclajes en acero galvanizado. Acabados de gran calidad. Certificado bajo Norma EN16630:2015.



#### VITA CIRCUIT

Classic outdoor workout circuit materials and esthetics appropriated for natural areas. Northern red pine, vacuum pressure treated wood, class P4, with open pore protection. Galvanized bars and fixings. High quality finish. Certified under EN16630:2015 standard



#### CIRCUIT VITA

Circuit classique d'entraînement en plein air, matériaux et esthétiques idéaux pour des environnements naturels. Les appareils sont fabriqués en Pin Rouge du Nord traité autoclave classe 4 et finition laser à pores ouverts. Barres et ancrages galvanisés. Certifié sous la norme EN16630:2015



Intensidad  
Intensity  
Intensité



Años  
Years  
Ans



Galería de fotos  
Photo gallery  
Galerie de photos



CIRCUITOS DEPORTIVOS / OUTDOOR SPORT CIRCUITS / CIRCUITS SPORTIFS  
**CIRCUITO VITA / VITA CIRCUIT / CIRCUIT VITA**



R7000



R7010



R7011



R7013



R7015



R7020



R7025



R7026



R7027



R7030



R7035



R7040



R7045

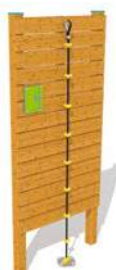

R7050



R7055



R7060

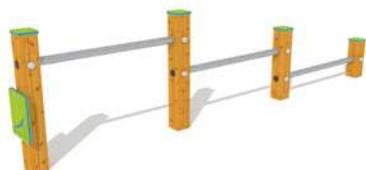

R7065



R7070



R7075

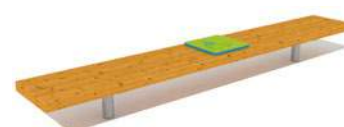

R7076

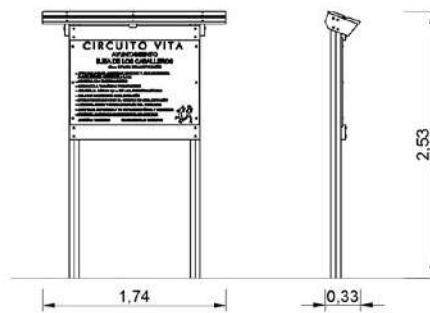

**Cartel general**  
 General Sign  
 Panneau d'information  
 générale

**R7000**

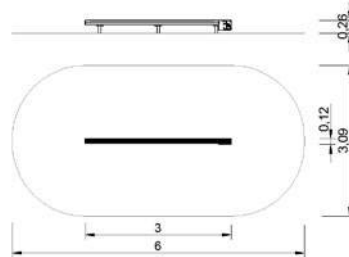

**Barra de equilibrio**  
 Balance beam  
 Barre d'équilibre

**R7010**

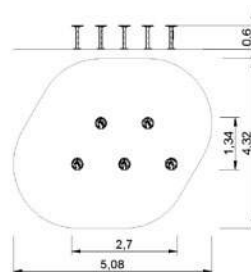

**Punto de equilibrio**  
 Balance point  
 Point d'équilibre

**R7011**

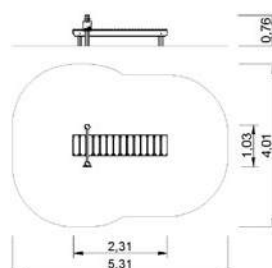

**Bancada de lumbares**  
 Lower back bench  
 Banc à lombaires

**R7013**





**Barras paralelas**  
 Parallel bars  
 Barres parallèles

**R7015**

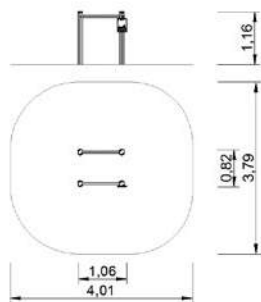

**Bancada de abdominales**  
 Sit up bench  
 Banc à abdominaux

**R7020**

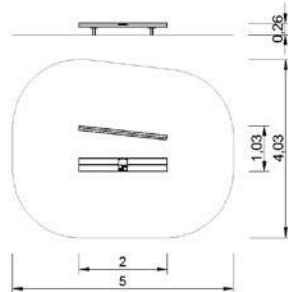

**Valla de salto**  
 Hurdle  
 Saut d'obstacles

**R7025**

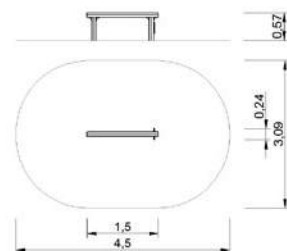

**Potro de salto**  
 Vaulting horse  
 Cheval d'arceau

**R7026**

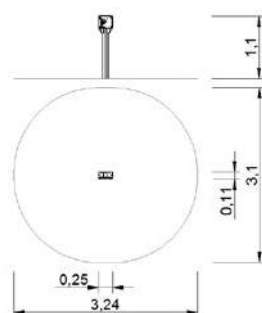

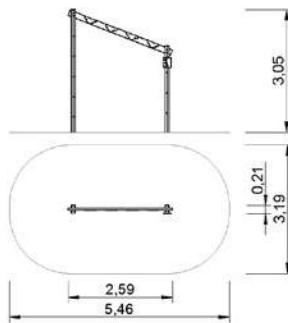

**Salto de toque**  
 Touch Jump  
 Sauter toucher à  
 plusieurs hauteurs

**R7027**

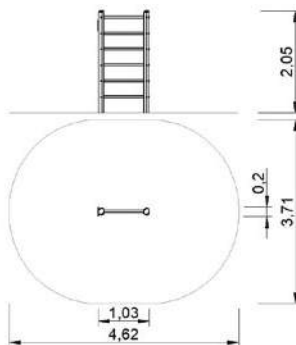

**Pared vertical**  
 Vertical wall  
 Paroi verticale

**R7030**

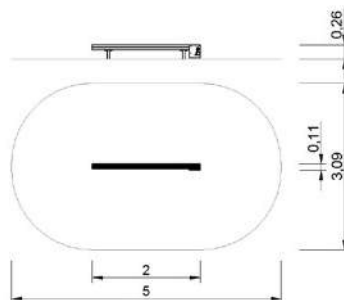

**Valla de salto lateral**  
 Lateral jump hurdle  
 Saut d'obstacle latéral

**R7035**

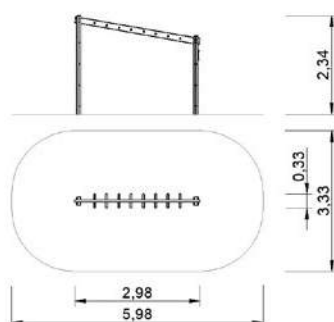

**Escalador**  
 Climber  
 Escalade

**R7040**





**Escalera inclinada**  
 Leaning ladder  
 Escalier incliné

**R7045**

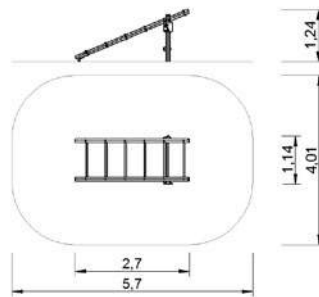

**Pared vertical con cuerda**  
 Vertical wall with rope  
 Paroi verticale avec corde

**R7050**

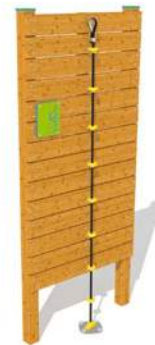
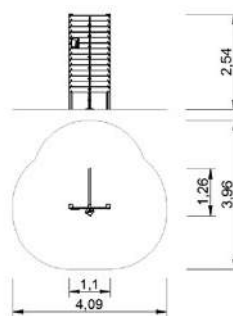

**Espaldera**  
 Wall bars  
 Espalier

**R7055**

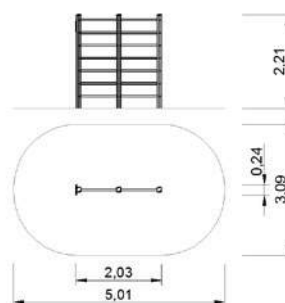

**Barras de salto horizontal**  
 Horizontal jump bars  
 Barres de saut horizontal

**R7060**

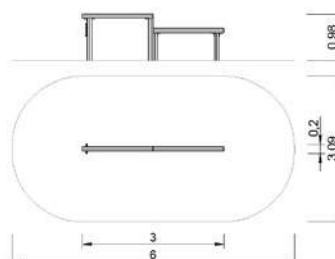

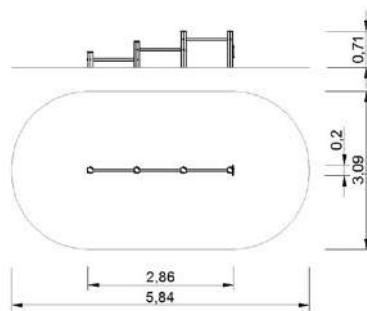
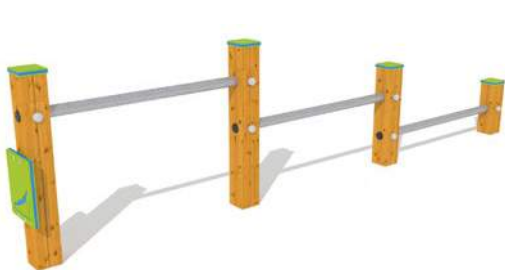

**Triple bancada de flexiones**  
 Triple pull up bench  
 Triple banc à flexions

**R7065**

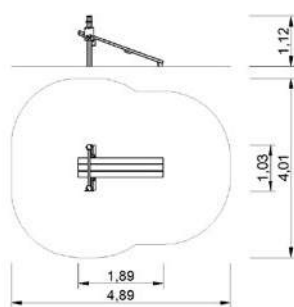

**Banco de abdominales**  
 Sit-up bench  
 Banc à abdominaux

**R7070**

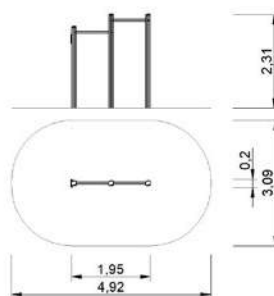

**Barra flexiones verticales**  
 Pull up double bar  
 Barres à flexions verticales

**R7075**

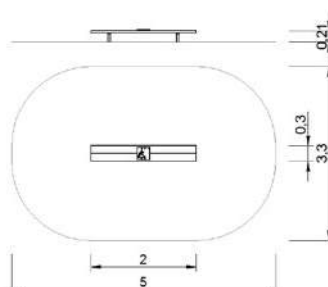
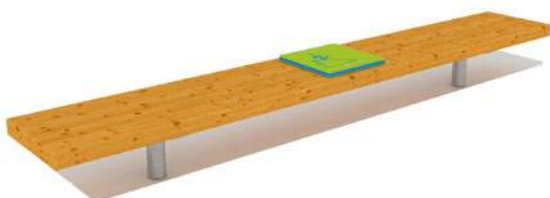

**Banco de estiramientos**  
 Stretch bench  
 Banc d'exercices

**R7076**









# Circuito Agility

## Agility Circuit

## Circuit Agility



### CIRCUITO AGILITY

El Agility es una competición canina abierta a todos los perros. Consiste en hacerles superar diferentes obstáculos con el fin de valorar y potenciar su inteligencia y agilidad. Se trata de una actividad educativa y deportiva que favorece su buena integración dentro de la sociedad. Esta disciplina implica una relación armónica entre el perro y su guía, lo que redundará en la perfecta relación del equipo. El recorrido está compuesto por la mayor variedad posible de obstáculos cuya colocación sobre el terreno determina el grado de dificultad y velocidad.

Industrias Agapito fabrica Circuitos Agility conformes al reglamento de la Federación Canina Internacional (Fédération Cynologique Internationale). Aptos para categorías S, M y L, según los distintos elementos (ver documentación técnica de cada producto). Diseñados y fabricados para su instalación en parques públicos en la intemperie, con materiales de máxima calidad como el acero galvanizado en caliente o el polietileno de alta densidad.



### AGILITY CIRCUIT

Dog agility is a canine competition open to all dogs. It involves guiding them over various obstacles in order to improve and evaluate their intelligence and agility. It is an educational and sporting activity that improves the dog's integration into society. The discipline demands a harmonious relationship between the dog and handler, which results in the perfect team relationship. The course consists of the widest possible range of obstacles, and their placement on the terrain determines the degree of difficulty and speed.

Industrias Agapito manufactures Dog Agility Courses in accordance with the regulations of the International Canine Federation (Fédération Cynologique Internationale). Suitable for categories S, M and L, according to the various components (see technical documentation for each product). Designed and manufactured for outdoor installation in public parks, and made with high-quality materials such as galvanized steel or high-density polyethylene.



### CIRCUIT AGILITY

L'agilité est un concours canin ouvert à tous les chiens. Il consiste à surmonter divers obstacles afin d'évaluer et d'améliorer leur intelligence et leur agilité. Il s'agit d'une activité éducative et sportive qui favorise la réussite de leur intégration au sein de la société. Cette discipline implique une relation harmonieuse entre le chien et son maître, qui se traduira par une parfaite relation d'équipe. Le parcours est composé de la plus grande variété possible d'obstacles dont le placement sur le terrain détermine le degré de difficulté et la vitesse.

Industrias Agapito fabrique des circuits Agility conformes aux règlements de la Fédération Canine Internationale (Fédération Cynologique Internationale). Convient aux catégories S, M et L, en fonction des différents éléments (voir la documentation technique de chaque produit). Conçu et fabriqué pour une installation dans les parcs publics en plein air, avec des matériaux de haute qualité tels que l'acier galvanisé à chaud ou le polyéthylène haute-densité.

Conforme a la Federación Canina Internacional.  
In accordance to the Federation Cynologique Internationale.  
Conformément aux norms de la Fédération Cynologique Internationale.



Galería de fotos  
Photo gallery  
Galerie de photos



CIRCUITOS DEPORTIVOS / OUTDOOR SPORT CIRCUITS / CIRCUITS SPORTIFS  
**CIRCUITO AGILITY / AGILITY CIRCUIT / CIRCUIT AGILITY**



R9000



R9002

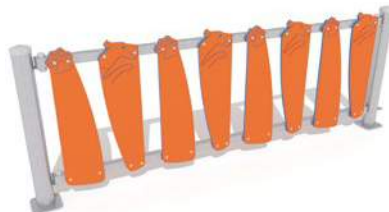

R3537

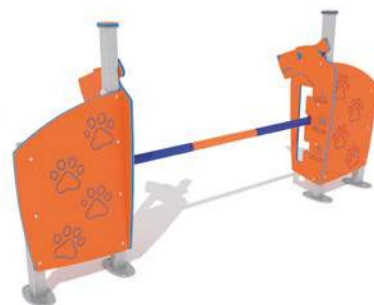

R9005

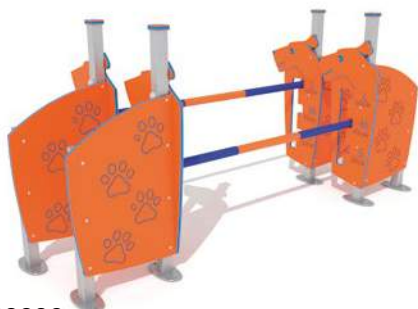

R9006



R9010



R9011



R9015



R9020



R9025



R9030



R9035



R9040

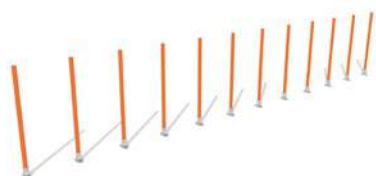

R9045



R9050



R9055



R3955



R3262

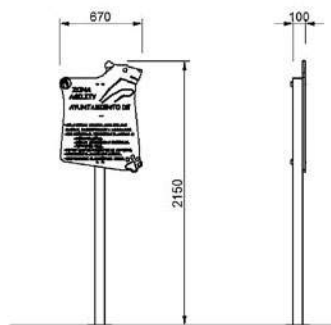

**Cartel Agility**  
 Agility sign  
 Panneau Agility

**R9000**

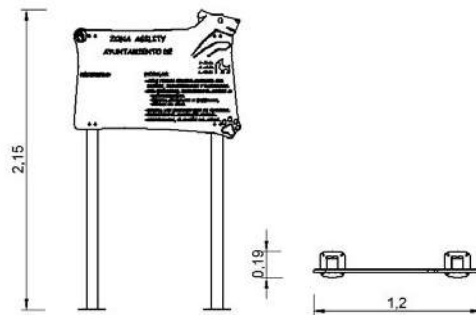

**Cartel grande Agility**  
 Large Agility sign  
 Grand panneau Agility

**R9002**

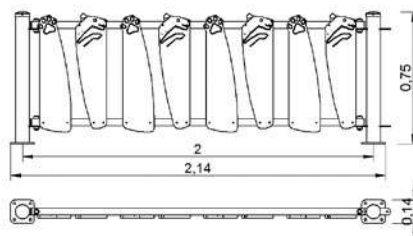
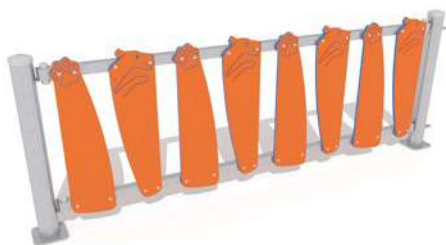

**Valla Agility**  
 Agility fence  
 Clôture agility

**R3537**

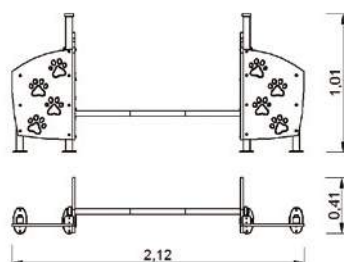
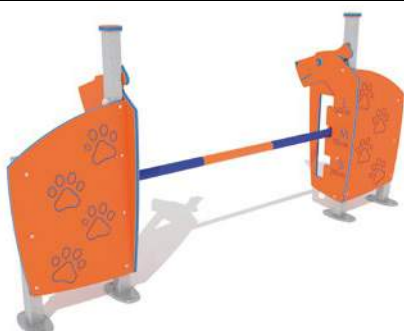

**Valla de salto**  
 Hurdle  
 Haie de saut

**R9005**

Regulable en altura  
 Adjustable height  
 Réglable en hauteur



\* Apto para las categorías S (pequeño), M (mediano) y L (grande).  
 Suitable for S (small), M (medium) and L (large) categories.  
 Convient aux catégories S (petit), M (moyen) et L (grand).



**Valla de salto agrupada**  
 Spread hurdles  
 Haies de saut groupées

**R9006**



Regulable en altura  
 Adjustable height  
 Réglable en hauteur

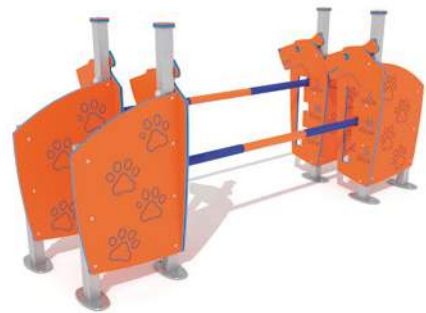
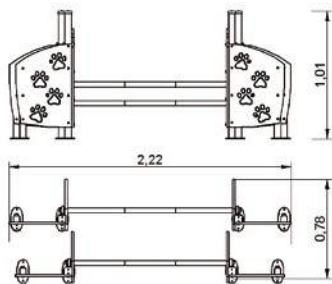

**Muro S y M**  
 Wall S and M  
 Mur S et M

**R9010**

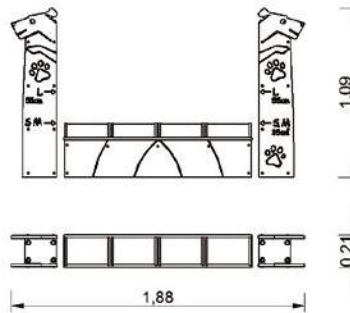

**Muro L**  
 Wall L  
 Mur L

**R9011**

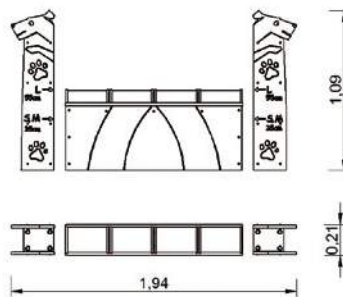

**Rueda**  
 Tyre  
 Le pneu

**R9015**



Regulable en altura  
 Adjustable height  
 Réglable en hauteur

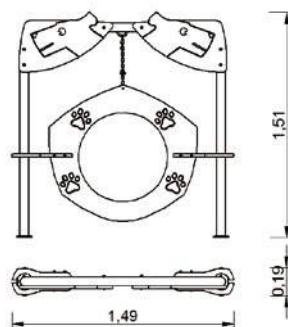

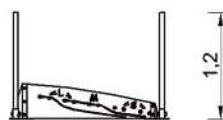
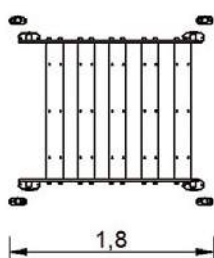

**Salto de longitud**  
Long jump  
Le saut en longueur

**R9020**

Longitud regulable según categorías  
Adjustable length according to categories  
Longueur réglable d'accord à la catégorie

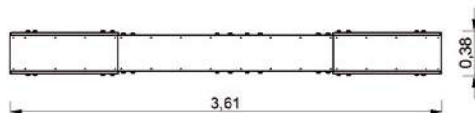
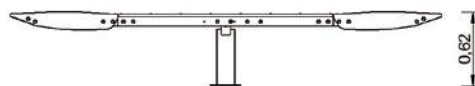

**Balancín**  
See-Saw  
Le balançoire

**R9025**

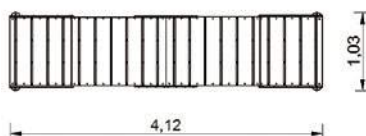
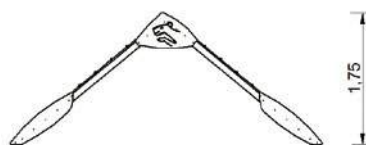

**Empalizada**  
A-frame  
La palissade

**R9030**

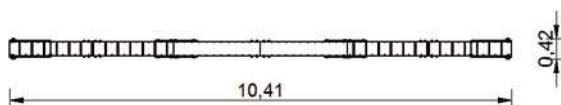

**Pasarela**  
Dog walk  
La passarelle

**R9035**



\* Apto para las categorías S (pequeño), M (mediano) y L (grande).  
Suitable for S (small), M (medium) and L (large) categories.  
Convient aux catégories S (petit), M (moyen) et L (grand).



**Tunel rígido**  
 Tube tunnel  
 Le tunnel rigide

**R9040**

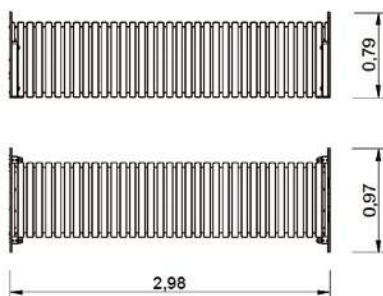

**Slalom**  
 Slalom  
 Le slalom

**R9045**

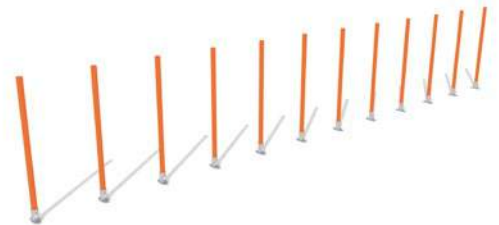
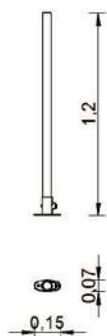

**Mesa**  
 Table  
 Le table

**R9050**

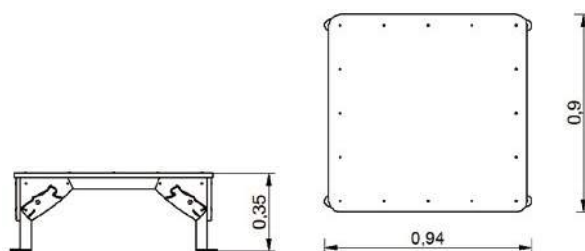

**Guardacanes**  
 Dog leash holder  
 Poteau attache-laisse

**R9055**

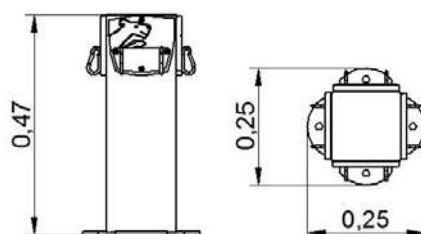



**Papelera canina**  
Dog litter bin  
Corbeille de propreté canine

**R3262**

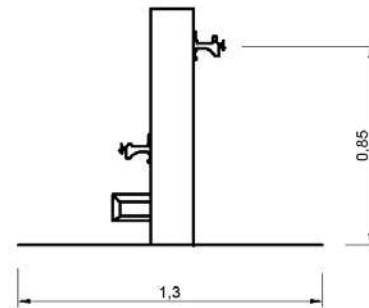
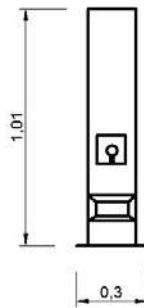

**Fuente doble**  
Fuente doble  
Fontaine double

**R3955**

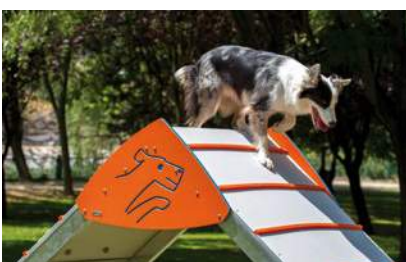



**HDPE MICROPERFORADO**  
MICROPERFORATED HDPE / PEHD MICROPERFORÉ



**PET+PVC IMPERMEABLE**  
WATERPROOF PET+PVC / PET+PVC IMPERMÉABLE

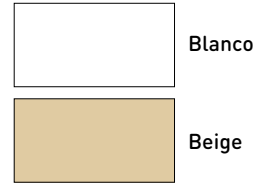





# Sombras Textiles

## Textile Shades

### Nuances Textiles



#### SOMBRAS TEXTILES

Las estructuras de sombra para parques infantiles y espacios urbanos son cada día más necesarias para la protección de los niños y adultos frente a las inclemencias meteorológicas, tanto en épocas de lluvia como de altas temperaturas. Ante esta necesidad las sombras textiles tensadas de Industrias Agapito son la solución idónea que se adapta a los requerimientos de cada parque infantil, colegio, área urbana, hotel, ayuntamiento, centro comercial, estación de servicio, área de descanso, zona turística y proyecto de arquitectura textil. Nuestras

cubiertas textiles para dar sombra están fabricadas con materiales de alta calidad que proporcionan una alta resistencia a la rotura y al desgarró. La carpa textil tensada se fabrica a partir de monofilamentos HDPE estabilizados contra UV y se sustenta en una estructura metálica con tensores de acero galvanizado y tornillería de acero inoxidable. Este tipo de cubrición textil bloquea el 98,8% de los rayos UV y está 100% libre de plomo y flatato. Las estructuras de sombra tensadas urbanas pueden ser fabricadas con formas de tipo vela, paraboloide

hiperbólico, cónico, tipo arco, fachadas textiles etc Las tensoestructuras para dar sombra ofrecen posibilidades infinitas y son una excelente solución para permitir a niños y familias disfrutar con comodidad de instalaciones públicas en el exterior. Dada nuestra amplia experiencia en el sector del mobiliario urbano y juegos infantiles somos altamente eficaces y eficientes gestionando proyectos de ocio urbano llave en mano haciéndonos cargo del diseño, fabricación, instalación y mantenimiento.

## CUBRICIÓN TEXTIL SAHARA

R3870

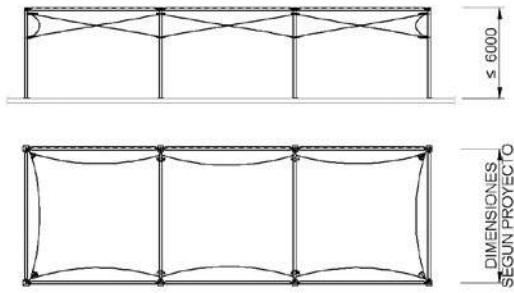

## CUBRICIÓN TENSADA ARABIA

R3872

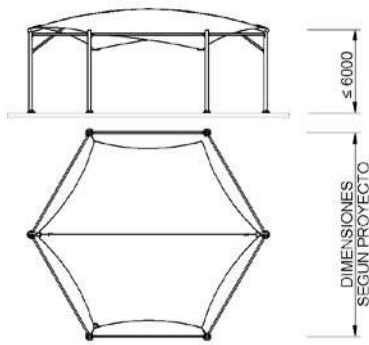

## CUBRICIÓN MODULAR GOBI

R3874

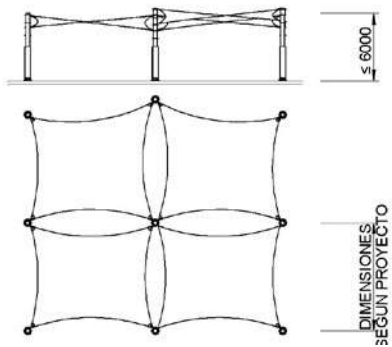

## CUBRICIÓN VELA KALAHARI

R3876

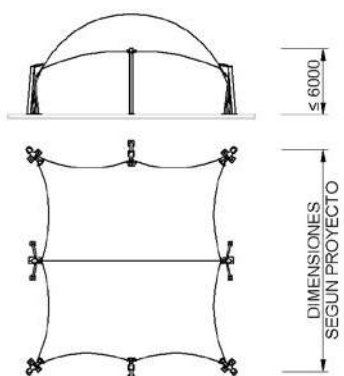



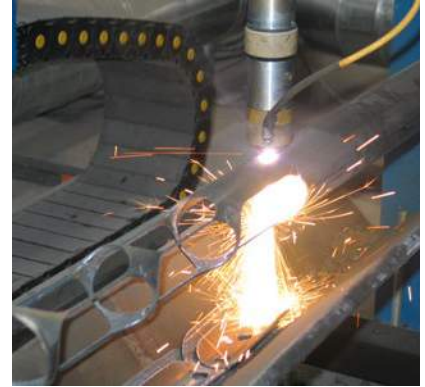



CG-20

Pol. Ind. Valdeferrín Oeste, C/ G, s/n  
50600 Ejea (Zaragoza) SPAIN  
T :: (+34) 976 660 879 • F :: (+34) 976 667 628

[www.industriasagapito.com](http://www.industriasagapito.com)  
[ventas@industriasagapito.com](mailto:ventas@industriasagapito.com)

- La empresa se reserva el derecho de realizar cambios en sus productos, por motivos de mejora o estructurales, en cualquier momento de la producción.
- In order to continually improve its products, the company reserves the right to change them without prior notice.
- Soucieux d'améliorer continuellement ses produits, Industrias Agapito se réserve le droit de les modifier à tout moment et sans préavis.

